

**XIRIUM**  
DIGITAL WIRELESS AUDIO NETWORK

**User Manual**

**DiWA**  
DIGITAL WIRELESS AUDIO

**NEUTRIK®**



# Contents

<b>A About this document</b>	<b>3</b>
Designations	3
Symbols on the device and packaging	3
Symbols in the documentation	4
Safety instructions	4
<b>B System components and accessories</b>	<b>6</b>
Controls	7
XTX	7
XRX	8
<b>C Functions</b>	<b>9</b>
XIRIUM X devices	9
XTX (transmitter)	9
XRX (receiver)	9
<b>D Installation of a single radio link</b>	<b>10</b>
Mounting the antennas	10
Setting the Repeater switches	11
Selecting the audio channel on the XTX device	11
Supplying power to the XTX master	11
Power supply	11
XIRIUM X battery pack	11
Starting the linking process	11
Selecting the audio channel on the XRX devices	12
Supplying power to the XRX devices	12
Power supply	12
XIRIUM X battery pack	12
Establishing the XTX-XRX link	12
Power supply	12
Completing the linking process	13
Connecting the audio sources	13
Connecting audio sinks	14
<b>E Configuration examples</b>	<b>15</b>
Multiple mono or stereo transmission	15
Mounting the antennas	15
Setting the Repeater switches	15
Selecting the audio channels	16
Supplying power to the XTX master	16
Starting the linking process	16
Supplying power to the XTX slaves and XRX receivers	17
Completing the linking process	17
Mono transmission with repeater	17
Mounting the antennas	18
Setting the Repeater switches	18
Selecting the audio channels	18
Supplying power to the XTX master	19

Starting the linking process	19
Supplying power to the repeater	19
Supplying power to the XRX receivers	19
Completing the linking process	19
Dual channel or stereo transmission with repeater	20
Mounting the antennas	20
Setting the Repeater switches	20
Selecting the audio channels	21
Supplying power to the XTX master	21
Starting the linking process	22
Supplying power to the repeater	22
Supplying power to the XTX slave and XRX receivers	22
Completing the linking process	22
<b>F Control options</b>	<b>23</b>
Mute/Link button on the XTX device	23
Muting the audio signals	23
Linking process	23
Displaying the audio signal level	23
Displaying the RF channel	24
Selecting the RF channel	24
<b>G Antenna Guide</b>	<b>25</b>
Radiation pattern	25
Diversity technology	25
Antenna selection	26
Recommended antenna/cable combinations	26
Alignment	27
Propagation of electromagnetic waves	28
Neutrik antenna range	28
Omnidirectional antennas	28
Directional antennas	28
<b>H After operation</b>	<b>29</b>
Discontinuing operation and disassembly	29
Transport	29
Storage	29
Care and cleaning	29
Servicing and repair	29
Disposal	29
<b>I Operation from the computer</b>	<b>30</b>
Installing the XIRIUM X Companion	30
System requirements	30
Download	30
Installing the software	30
Using the XIRIUM X Companion	31
Starting the program	31
Software structure	31



Menu bar	32
Firmware update	32
Closing the program	33
Deinstalling the software	33
<b>J Service</b>	<b>33</b>
Contact	33
Troubleshooting	33
Conformity declaration	33
<b>K Technical data</b>	<b>34</b>

## A About this document

This document describes safe use of the XIRIUM X multichannel wireless network (referred to below as the **XIRIUM X system**). The **XIRIUM X system** comprises the XIRIUM X devices (**XTX** and **XXR**), antennas, power supplies and other accessories such as the XIRIUM X battery packs and connection cables.

### ■ Designations

Designation	Note
XIRIUM X system	All components: XIRIUM X devices, cables, connectors, XIRIUM X battery packs
XIRIUM X devices	<b>XTX devices, XXR devices</b>
Peripheral device	All devices that can be connected to the XIRIUM X devices: Audio sources (transmitters) and audio sinks (receivers)
Audio source	All devices that transmit audio signals, e.g. instruments, microphones, tablets, MP3 devices, audio systems (amplifiers, mixers etc.)
Audio sink	All devices that receive audio signals, e.g. speakers, audio systems (amplifiers, mixers etc.)

### ■ Symbols on the device and packaging

Symbol	Explanation
	CE conformity mark. The product was manufactured in compliance with applicable standards.
	Do not dispose of devices in domestic waste.
	Warning symbol. Read the instructions.



## Symbols in the documentation

Symbol	Explanation
	Pre-requisite: These conditions must be met before the following instructions are executed.
	Instruction: This requires action on your part.
	Result: Result of an executed instruction.
	Notes and tips for safe use of the devices and accessories: Observe these notes.
	Warning symbol: Highlights dangerous situations. Non-observance can result in personal injury.
<b>CAUTION!</b>	Warning: Highlights dangerous situations. Non-observance can result in damage to equipment.

## Safety instructions

- ▶ Carefully read the information contained in the User Manual for safe use of the XIRIUM X system and all accessories.
- ▶ Always keep this User Manual near the XIRIUM X devices for easy reference.
- ▶ Read and comply with the instructions of use for the connected peripheral devices.

### Intended use

- ▶ Only use the XIRIUM X devices in accordance with the description in this User Manual.
- ▶ Never use any accessories that are not expressly designed for the XIRIUM X devices.

The XIRIUM X devices are not designed for outdoor use.

- ▶ Only use the XIRIUM X devices indoors.
- ▶ Protect the XIRIUM X devices against knocks and prevent them falling from shelves, tables or other items of furniture.

Damage to equipment caused by unsuitable operating and ambient conditions!

- ▶ Protect the XIRIUM X devices against dirt, dust, liquids, moisture, heat and full exposure to sunlight.
- ▶ Ensure that there is sufficient space between the XIRIUM X devices and other objects, especially those that become very warm themselves. To prevent overheating, never cover the devices.

Risk of injury and damage to equipment caused by incorrect repairs! The XIRIUM X devices do not contain any parts that you can repair yourself.

- ▶ Never open the housing of the XIRIUM X devices or replace any parts yourself. Unauthorised opening or repair can result in serious damage to the devices and injury to the operator.
- ▶ Only have the XIRIUM X devices repaired by an authorised dealer.

### Power packs

- ▶ Only use the special XIRIUM X battery packs for powering the XIRIUM X devices. Ensure that the XIRIUM X battery packs are undamaged and fully charged.
- ▶ Only use power packs with the same technical ratings for powering the XIRIUM X devices. Never use power packs with different charge levels.

### Electrical connection

Risk of electric shock!

- ▶ Only connect the XIRIUM X devices to correctly installed power sockets.
- ▶ Do not touch the XIRIUM X devices or the connections with moist or wet hands.
- ▶ Ensure that the mains voltage and frequency of the XIRIUM X devices corresponds with the ratings of the supply network.
- ▶ Only use the supplied power supplies for connection to a power socket. Never make any modifications to the power supply.
- ▶ Before switching on the XIRIUM X devices always ensure that the power supply or the XIRIUM X battery pack shows no visible signs of damage, dents or kinks, flaws or cracks. Only use an undamaged power supply for connection to the power circuit.
- ▶ If the XIRIUM X devices are not used for a prolonged period of time, switch all the devices off and remove the mains connector from the socket.
- ▶ In the event of thunderstorms or the risk of voltage fluctuations in the power network: Switch the XIRIUM X devices off and remove the mains connector from the power socket.





- ▶ Ensure that the mains cables are not kinked during operation, do not hang over sharp edges or come in contact with warm or hot surfaces.
  - ▶ Never use the XIRIUM X devices if damage or faults occur on the power supply, the individual devices, indicators, controls or accessories.
- **Please observe the following during operation:**
- ▶ Ensure that the ambient conditions specified for the XIRIUM X devices in the technical data are complied with during operation.
  - ▶ Never use the XIRIUM X devices if they do not work correctly, have been dropped or damaged, become wet or if parts have been immersed in water.
  - ▶ Switch the XIRIUM X devices off immediately and disconnect them from the power supply if faults occur during operation.
  - ▶ Do not use the XIRIUM X devices in rooms in which flammable or explosive substances, gases or vapours are present or can occur.



## B System components and accessories



Item	XIRIUM X / Accessories	
1	XTX (transmitter)	NXX1TX-T
2	XRX (receiver)	NXX1RX-T
<b>Accessories</b>		
3	Rod antenna	NXA-3-360
4	Directional antenna	NXA*
5	Omnidirectional antenna	NXA-10-360-10
6	Installation adapter for the directional antenna	NXA-SMA-MM
7	Antenna cable	NKXA*
8	Data cable	NKX-DATA
9	5-V power supply with Tiny-XLR connector	NPS-10W-T
10	XIRIUM X battery pack	NXBP-T-6
11	Manfrotto™ universal mounting clamp	NXUC-M-15
12	Flight Case XIRIUM X – Basic Setup	CAS-NXX-BASIC
13	Quick Start Guide	

\* For the recommended antenna cable combination please refer to the section "G Antenna Guide" on page 26.



## ■ Controls

### □ XTX

— XTX front

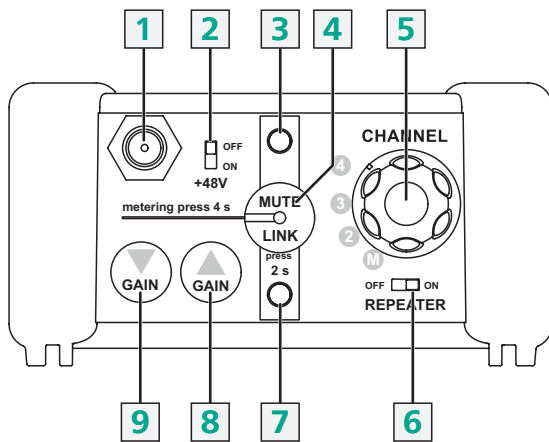

— XTX rear

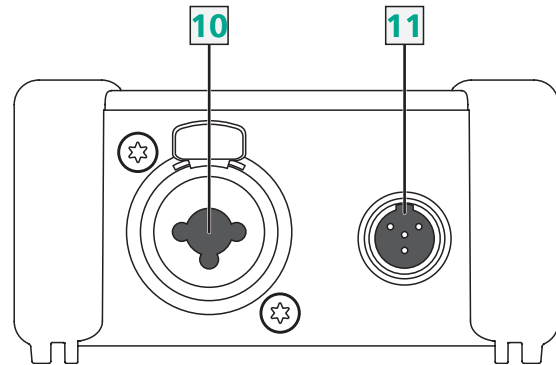

Item	Designation	Explanation
1	<b>Antenna connection</b>	SMA connectors for antennas *)
2	<b>Impedance switch</b>	Switch between phantom power / Hi-Z or line level.
3	<b>Mute LED</b>	Mute indicator <ul style="list-style-type: none"> <li>• <b>red</b>: The device/audio channel is muted.</li> <li>• <b>green</b>: The impedance switch is set to <b>ON</b>, a 1/4" TS connector is inserted. The device is ready for a Hi-Z instrument signal (e.g. direct connection of a guitar).</li> <li>• flashes in <b>green</b>: The impedance switch is set to <b>ON</b>, the condenser microphone (48 V) can be supplied with phantom power.</li> </ul>
4	<b>Mute/Link button</b>	<ul style="list-style-type: none"> <li>• Switch the audio channel to mute.</li> <li>• Start and finish the linking process.</li> <li>• Indication functions</li> </ul>
5	<b>Channel select</b>	Set audio channel <b>M, 2, 3</b> or <b>4</b> .
6	<b>Repeater switch</b>	Switch repeater mode on and off
7	<b>Status LED</b>	Indicator for: <ul style="list-style-type: none"> <li>• RF ON</li> <li>• Linking process</li> <li>• Input signal (dBFS)</li> <li>• RF channel</li> <li>• Changing the RF channel</li> </ul>
8	<b>Gain-up</b>	Increase the volume.
9	<b>Gain-down</b>	Lower the volume.
10	<b>Combo socket</b>	Connection socket for analogue audio sources with XLR connector, 1/4" TRS connector or 1/4" TS connector
11	<b>Tiny-XLR connection</b>	Connection for 5V power supply via the Tiny-XLR connector

\*) When using a remote antenna including antenna cables we recommend securing the cable with a spanner (tightening torque = 1 Nm).

▣ **XRX**

— **XRX front**

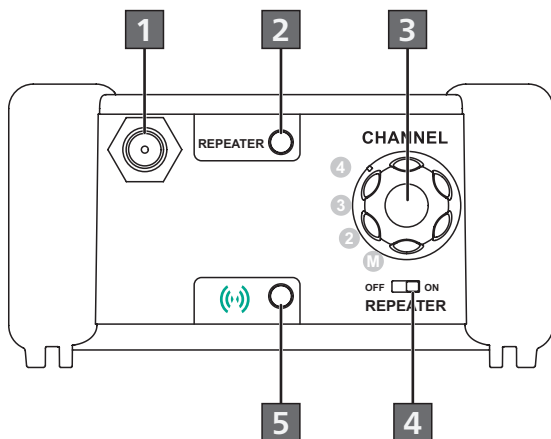

— **XRX rear**

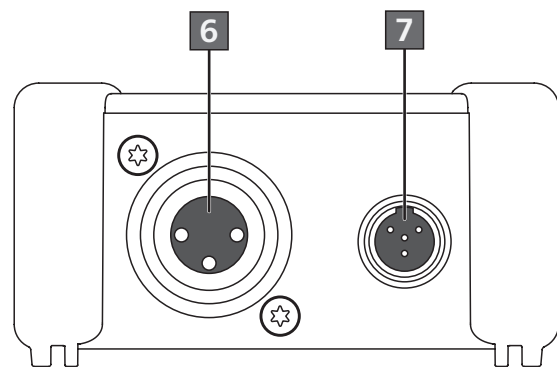

Item	Designation	Explanation
1	<b>Antenna connection</b>	SMA connectors for antennas *)
2	<b>Repeater LED</b>	Repeater mode display
3	<b>Channel select</b>	Set audio channel <b>M</b> , <b>2</b> , <b>3</b> or <b>4</b> .
4	<b>Repeater switch</b>	Switch repeater mode on and off
5	<b>RF status LED</b>	Reception quality indication <b>green</b> : Reliable reception quality <b>orange</b> : Unreliable, good reception quality <b>red</b> : No reception
6	<b>XLR-OUT</b>	XLR output to analogue audio sinks
7	<b>Tiny-XLR connection</b>	Connection for 5V power supply via Tiny-XLR

\*) When using a remote antenna including antenna cables we recommend securing the cable with a spanner (tightening torque = 1 Nm).



## C Functions

With the **XIRIUM X system** it is possible to replace conventional cable connections between all types of audio sources and audio sinks (referred to in this manual as peripheral devices) by a wireless connection.

**XIRIUM X** transmits audio signals without losses on four audio channels within one radio channel (RF channel) on the 5-GHz band with a range of up to 500 metres.

Four RF channels are available in the system. Up to four audio signals can be transmitted on the selected RF channel.

**XIRIUM X** automatically searches for a free frequency.

Channel	Medium frequency
Ch 36	5180 MHz
Ch 40	5200 MHz
Ch 44	5220 MHz
Ch 48	5240 MHz

Different applications are possible with the direct transmission between the audio source and the audio sink or the repeater mode. In repeater mode the audio signals can also overcome obstacles and also be transmitted to the receivers if there is no direct visual contact.

### ■ XIRIUM X devices

For the simplest configuration of the **XIRIUM X system** you require an audio source, an XTX device, an XRX device and an audio sink.

The audio source is connected to the XTX device.  
The audio sink is connected to the XRX device.  
The XTX device and the XRX device are connected wirelessly.

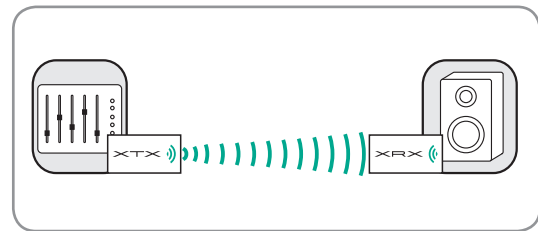

#### □ XTX (transmitter)

The XTX device is the transmitter and can be used as a master or slave.

- Audio sources are connected directly to the XTX master. The XTX master sends audio signals to the XRX devices. The XTX master synchronises the entire XIRIUM X system and sends the sync information to the XTX slave and all XRX devices.
- Audio sources are connected to the XTX slave. The XTX slave sends audio signals to the XRX devices.

#### □ XRX (receiver)

The XRX device is the receiver and is either used as a “simple” receiver or as a repeater.

- The XRX receiver receives audio signals from XTX devices. An audio sink is connected to the XRX receiver.
- The repeater receives audio signals from XTX devices and transmits them without losses to the XRX receivers. A repeater can receive and forward two audio signals. It is therefore possible to transmit stereo or multiple mono signals through a repeater.

#### — Repeater mode

With the repeater mode the system can be extended by two important functions:

- **Extension of the transmission range:** Obstacles can be overcome. The receiver in repeater mode receives the audio signal from the transmitter and forwards it to the other receivers.
- **Diversity:** If you use an XRX device as a repeater, the reception reliability in the XIRIUM X system can be further enhanced. The XTX receiver works with diversity, i.e. it automatically uses the stronger signal, either directly from the XTX device or from the repeater.

In repeater mode a repeater can forward up to two audio signals. Only one repeater can be used per RF channel.



## D Installation of a single radio link

Installation of a single radio link between an XTX transmitter and any number of XRX receivers in broadcast mode.

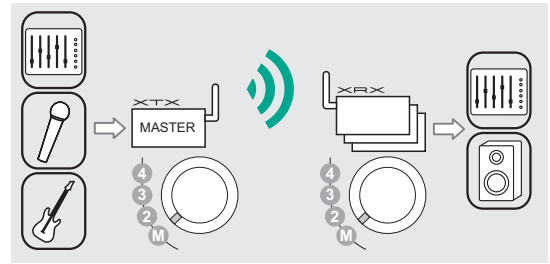

This example shows the simplest, direct transmission path from an audio source to the audio sink through an audio channel.

The XTX master sends the audio signal from the audio source to the XRX client that is connected to an audio sink. Several XRX devices can be used in broadcast mode. All XRX receivers receive the same audio signals from the XTX master.

**!** Broadcast mode enables you to connect any number of XRX receivers to one XTX device. These XRX devices all receive the same audio signal from the XTX device on one audio channel.

### — For this installation you require:

- One XTX device
  - Any number of XRX devices (for broadcast mode)
  - One antenna for each XIRIUM X device
  - One audio source with a suitable connection cable
  - One audio sink per XRX device with a suitable connection cable
  - Power supplies or XIRIUM X battery packs for the XIRIUM X devices
- ▶ Unpack all parts for this setup. Keep the original packaging for transport or storage purposes.
  - ▶ Check the contents of the packaging for visible transport damage.
  - ▶ Check whether the supplied items comply with the information on the delivery note.
  - ▶ If the packaging or supplied parts are damaged: Do not start operation of the devices. Contact the vendor or the Neutrik customer service department.

## ■ Mounting the antennas

Antennas must be mounted on the XIRIUM X devices for wireless transmission.

**!** Select the correct antenna for your configuration. For more information on this topic, refer to the section "G Antenna Guide".

- ▶ Mount the antennas onto the **antenna connections** **1**, **1** of the XIRIUM X devices.
- ▶ Align the antennas.

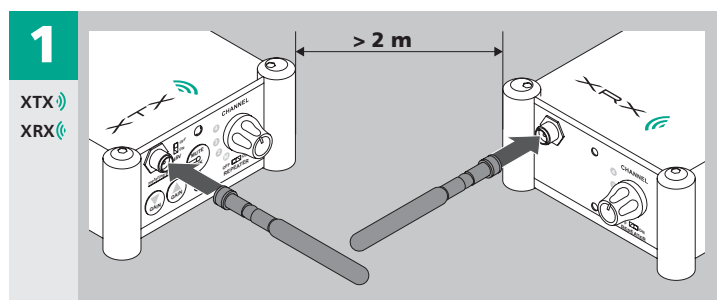

## ■ Setting the Repeater switches

- ▶ Set the **Repeater switches** 6, 4 on the XTX device and on all XRX devices to **OFF**.

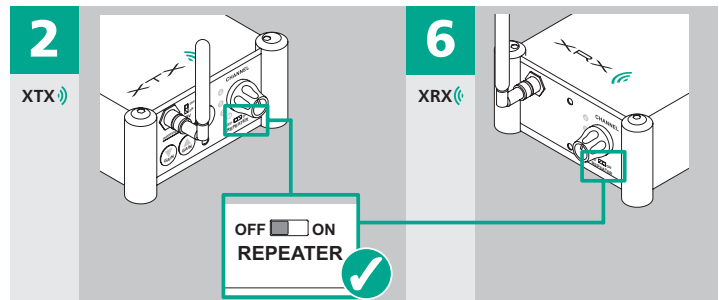

## ■ Selecting the audio channel on the XTX device

- ▶ Set the **Channel select dial** 5 of the XTX device to **M**.
  - The XTX device is then the XTX master.

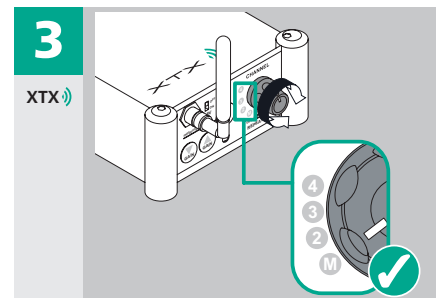

## ■ Supplying power to the XTX master

The XIRIUM X devices are supplied with power by means of a power supply or the XIRIUM X battery pack.

### □ Power supply

If the XTX master is near a power socket, use the power supply.

- ▶ Only use the supplied power supply.
- ▶ Connect the Tiny-XLR connector to the **Tiny-XLR socket** 11 of the XTX master.
- ▶ Insert the mains connector into a mains power socket.
  - The XTX master switches on automatically.

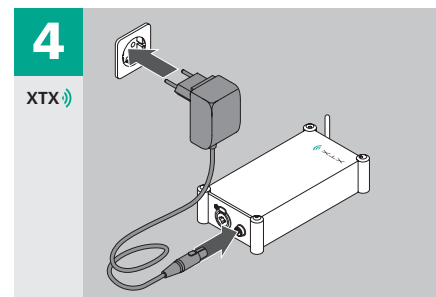

### □ XIRIUM X battery pack

If the XIRIUM X devices are not near a power socket, use the XIRIUM X battery pack to power the XIRIUM X devices.

! To fit the XIRIUM X battery pack, refer to the instructions.

- ▶ Fit the XIRIUM X battery pack on the XTX master.
  - The XTX master switches on automatically.

## ■ Starting the linking process

- ▶ Press and hold the **Mute/Link button** 4 of the XTX master until the **status** 7 lights up briefly in **orange** and then flashes in **green**.
  - The linking process on the XTX master is then initiated.

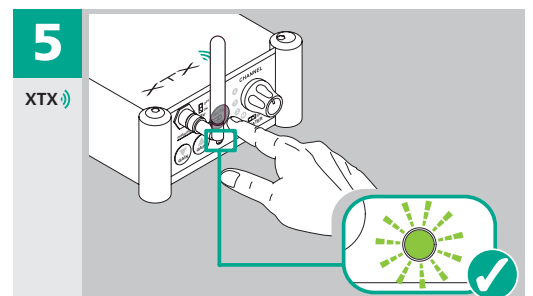

## ■ Selecting the audio channel on the XRX devices

- ▶ Set the **Channel select dial** **5** of all XRX devices to **M**.
  - The XRX devices become XRX receivers and receive audio signals on audio channel **M**.

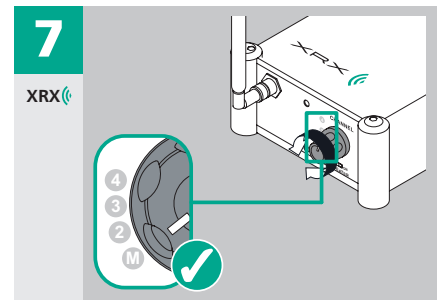

## ■ Supplying power to the XRX devices

The XIRIUM X devices are supplied with power by means of a power supply or the XIRIUM X battery pack.

### ▣ Power supply

If the XRX receivers are near a power socket, use the power supply.

- ▶ Only use the supplied power supply.
- ▶ Connect the Tiny-XLR connector to the **Tiny-XLR socket** **7** of the XRX receivers.
- ▶ Insert the mains connector into a mains power socket.
  - The XRX receivers switch on automatically

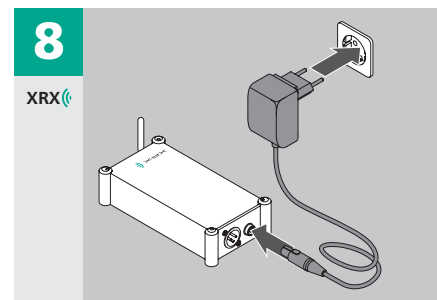

### ▣ XIRIUM X battery pack

If the XRX receivers are not near a power socket, use the XIRIUM X battery pack to power the XRX receivers.

**!** To fit the XIRIUM X battery pack, refer to the instructions.

- ▶ Fit the XIRIUM X battery pack on the XRX devices
  - The devices switch on automatically.

## ■ Establishing the XTX-XRX link

**!** Ensure that the receiving antennas are at least **two metres** away from the transmitting antennas to prevent interference occurring due to close proximity.

### ▣ Power supply

- ▶ Ensure that the XRX devices are within the range of the XTX master.
  - The XRX receivers automatically connect to the XTX master.
  - When the link has been established, the **RF status LED** **5** on the XRX receiver switches from **red** to **green**.

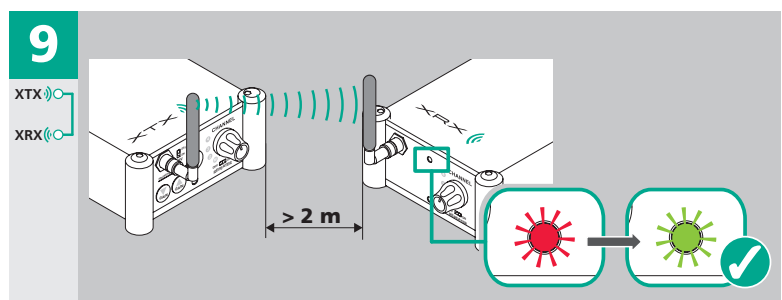

## ■ Completing the linking process

- ☑ All XRX receivers have connected to the XTX master.
- ☑ All **RF status LEDs 5** on the XRX receivers light up **green**.
- ▶ Briefly press the **Mute/Link button 4** on the XTX master.
  - The linking process is completed.
  - The **status LED 7** on the XTX master stops flashing in **green** and lights up permanently in **green**.

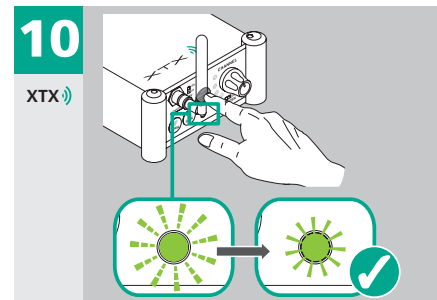

## ■ Connecting the audio sources

Audio sources such as dynamic microphones, condenser microphones, instruments (Hi-Z signal) and line level signals are connected to XTX devices.

**!** To prevent signal peaks we recommend activating the mute function on the XIRIUM X devices before connecting the peripheral devices. (Switch the devices to mute.)

**CAUTION!** Incorrect connection ratings can result in damage to the device, the accessories and the connected audio source!  
 ▶ Ensure that the input signal on the XTX device is set correctly (phantom power / HI-Z or line).

### — Phantom power / HI-Z or line adjustment

You can set the XTX master so that you can use the phantom power / HI-Z or line-in. Select the corresponding input signal for the respective devices (dynamic microphones and line signals or electric guitars and condenser microphones).

- ▶ Slide the **impedance switch 2** to **ON**.
  - The input for the audio source is used for phantom supply.
  - You can now either connect a condenser microphone with the XLR connector or an instrument signal (Hi-Z) with a ¼" TS connector.
- ▶ Slide the **impedance switch 2** to **OFF**.
  - The input for the audio source is switched to line.
  - With this input signal setting you can connect devices with line level (e.g. mixers) or dynamic microphones (XLR connectors or ¼" TS connectors).

<b>Dynamic microphone or line signal</b>		XLR	OFF ON
		1/4" TRS	<b>+48V</b>
<b>Condenser microphone</b>		XLR	OFF ON
		1/4" TS	<b>+48V</b>

### — Connecting an audio source

- ▶ Connect a suitable audio cable to the audio source.
- ▶ Insert the connector of the audio cable into the **combo input socket 10** on the XTX device.

## ■ Connecting audio sinks



To prevent signal peaks we recommend activating the mute function on the XTX device before connecting the audio sinks. (Switch the devices to mute.)



### **Caution!**

Risk of hearing damage!

Risk of damage to the audio sink if the volume is set too high!

- ▶ Set the volume of the audio source to minimum before connecting to the XTX device.

Audio sinks such as speakers, headphones, audio amplifiers and mixers are connected to the XRX devices.

- ▶ Connect a suitable audio cable to the audio sink.
- ▶ Insert the connector of the audio cable into the **XLR-OUT socket 5** on the XRX device.

**The XIRIUM X system is now ready for use.**

## E Configuration examples

Three typical applications and their configurations are described in detail below.



First make sure you understand the functions of the XIRIUM X devices. To this purpose read the sections “C Functions” and “D Installation of a single radio link”.

### ■ Multiple mono or stereo transmission

Transmission of multiple mono or stereo audio signals on up to four audio channels within one RF channel.

In the event of multi-channel transmission, all audio signals are transmitted synchronously. In broadcast mode any number of XRX receivers can receive the audio signal of an audio channel.

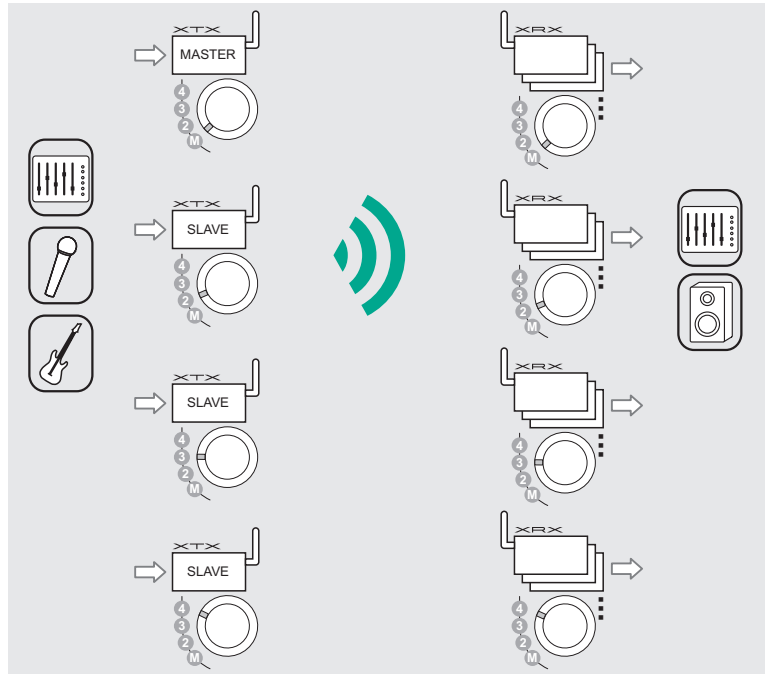

#### — For this installation you require:

Necessary devices and components

- At least two and at the most four XTX devices
- At least two XRX devices
- One antenna for each XIRIUM X device.
- One audio source for each XTX device with a suitable connection cable
- One audio sink for each XRX device with a suitable connection cable

#### □ Mounting the antennas

- ▶ Select the correct antennas for your configuration.
- ▶ Mount an antenna on each XIRIUM X device.
- ▶ Align the XIRIUM X devices and antennas.

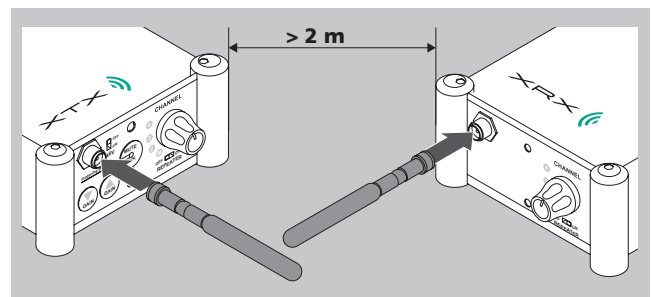

#### □ Setting the Repeater switches

- ▶ Set the **Repeater switches** **6**, **4** on all XTX and XRX devices to **OFF**.

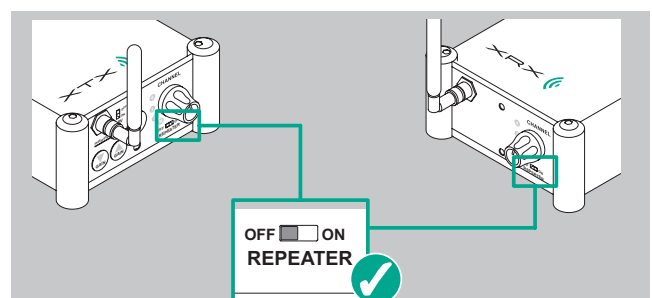

**□ Selecting the audio channels**

— **XTX master**

- ▶ On one XTX device set the **Channel select dial** **5** to **M**.
  - This XTX device has the master function.

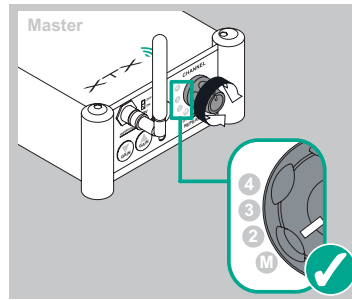

— **XTX slave**

- ▶ On the other XTX devices set the **Channel select dial** **5** to **2, 3** and **4**.
  - These XTX devices are then XTX slaves.
  - If the **Channel select dial** is set to **2**, this **XTX slave** transmits on audio channel **2**.
  - If the **Channel select dial** is set to **3**, this **XTX slave** transmits on audio channel **3**.
  - If the **Channel select dial** is set to **4**, this **XTX slave** transmits on audio channel **4**.

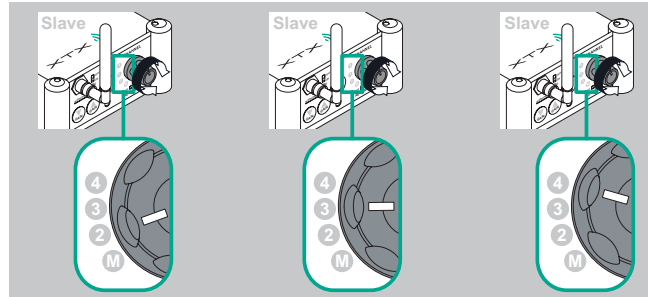

— **XRX receivers**

- ▶ On the XRX receivers set the **Channel select dial** **3** to **M, 2, 3** or **4**, depending from which XTX device the XRX receiver should receive the audio signal.
  - The XRX receivers receive audio signals on audio channel **M, 2, 3** or **4**.

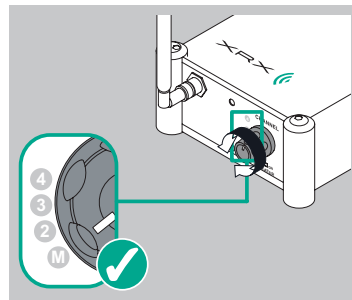

**□ Supplying power to the XTX master**

- ▶ Connect a power supply or a XIRIUM X battery pack to the XTX master.
  - The XTX master switches on.

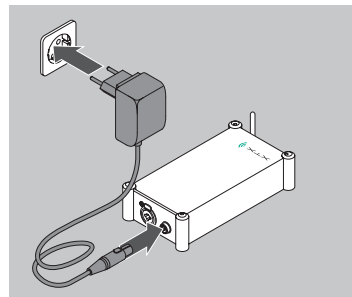

**□ Starting the linking process**

- ▶ Press the **Mute/Link button** **4** on the XTX master for two seconds until the **status LED** **7** lights up briefly in **orange**.
  - The **status LED** **7** flashes in **green**: The linking process is then initiated.

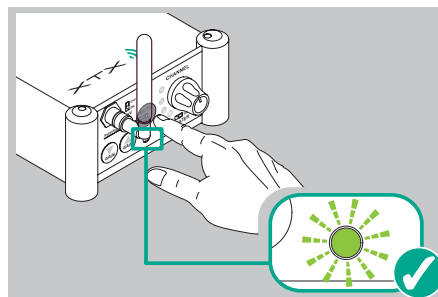



▣ **Supplying power to the XTX slaves and XRX receivers**

- ▶ Connect the power supplies or XIRIUM X battery packs to the XTX slaves and the XRX receivers.
  - The XTX slaves and XRX receivers switch on.

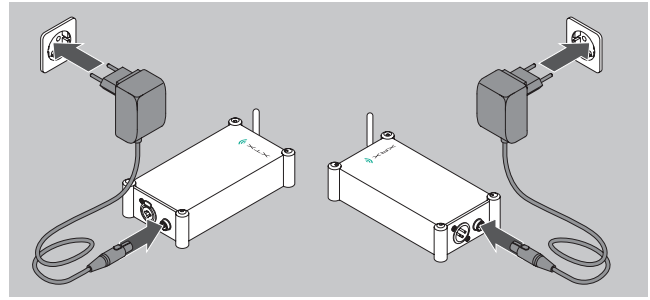

! The **status LEDs** 7 of the XTX slave and the **RF status LEDs** 5 of the XRX receivers switch from **red** to **green** when the link has been established.

▣ **Completing the linking process**

- ▶ Briefly press the **Mute/Link button** 4.
  - The **status LED** 7 switches from flashing **green** and lights up permanently in **green**.
  - The linking process is completed.

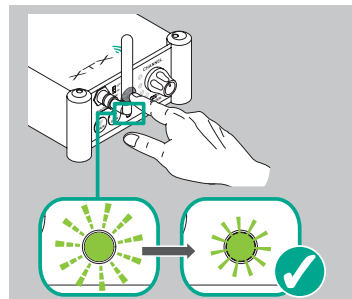

The XIRIUM X system is now ready for use.

■ **Mono transmission with repeater**

To overcome obstacles or enhance the reception reliability with diversity, one XRX device is used in repeater mode.

**Extended true diversity**

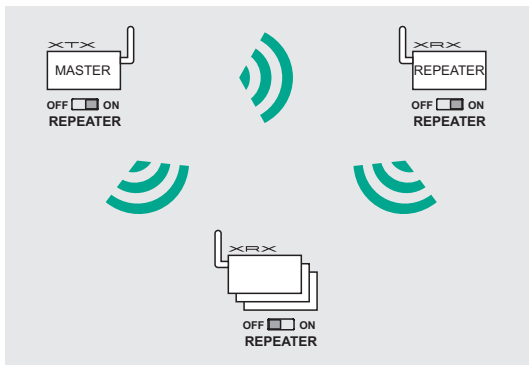

**Extension of the transmission range / overcoming obstacles**

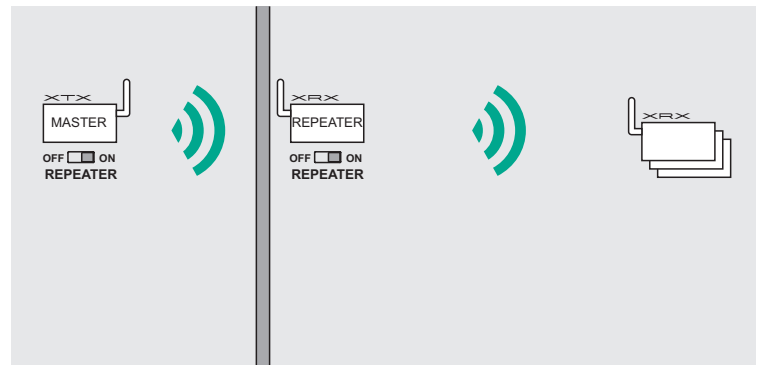

— **For this installation you require:**

Necessary devices and components

- One XTX device as master
- One XRX device as repeater
- Any number of XRX devices as receivers
- One antenna for each XIRIUM X device.
- One audio source with a suitable connection cable
- One audio sink for each XRX device with a suitable connection cable



**Mounting the antennas**

- ▶ Select the correct antennas for your configuration.
- ▶ Mount an antenna on each XIRIUM X device.
- ▶ Align the XIRIUM X devices and antennas.

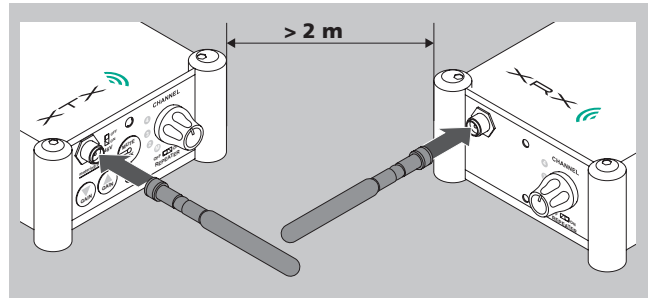

**Setting the Repeater switches**

- ▶ Set the **Repeater switches** 6, 4 on the XTX device and one XRX device to **ON**.
  - The XTX device is then the master.
  - This XRX device is then the repeater.

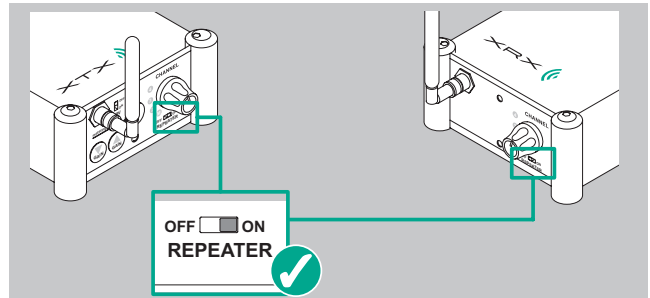

- ▶ Set the **Repeater switches** 4 on all other XRX devices to **OFF**.
  - These XRX devices are then XRX receivers.

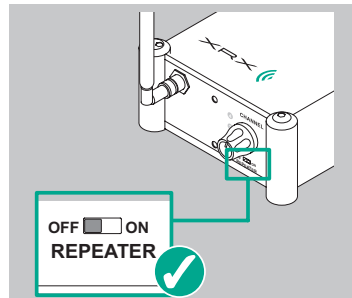

**!** Only one repeater can be used for each RF channel.

**Selecting the audio channels**

**!** If a repeater is used, the number of usable audio channels is limited to two.

**— XTX master**

- ▶ Set the **Channel select dial** 5 on the XTX device to **M**.
  - This XTX device has the master function.

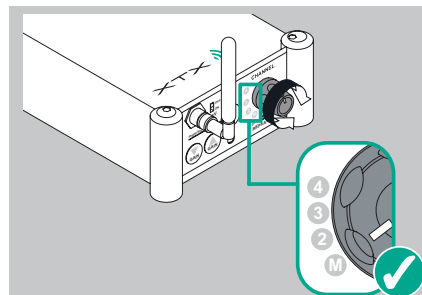

**— XRX receivers**

- ▶ Set the **Channel select dial** 3 on the XRX receivers to **M**.
  - The XRX receivers receive audio signals on audio channel **M**.

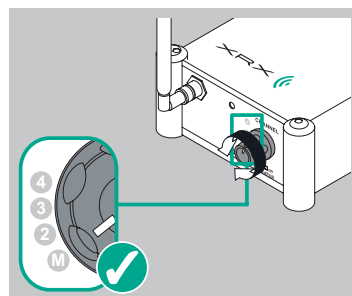

### □ Supplying power to the XTX master

- ▶ Connect a power supply or a XIRIUM X battery pack to the XTX master.
  - The XTX master switches on.

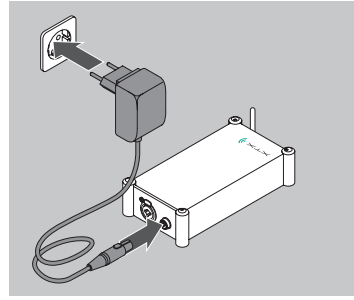

### □ Starting the linking process

- ▶ Press the **Mute/Link button** **4** on the XTX master for two seconds until the **status LED** **7** lights up briefly in **orange**.
  - The **status LED** **7** flashes in **green**: The linking process is then initiated.

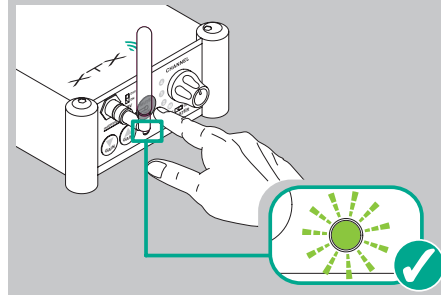

### □ Supplying power to the repeater

- ▶ Connect a power supply or a XIRIUM X battery pack to the repeater.
  - The repeater switches on.
  - The **repeater LED** **2** flashes in **green**.
  - The **RF status LED** **5** lights up in **red**.

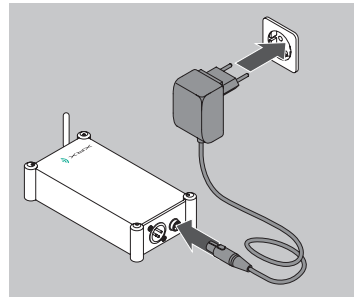

The **RF status LED** **5** on the repeater changes from **red** to **green** when the link has been established.

### □ Supplying power to the XRX receivers

- ▶ Connect a power supply or a XIRIUM X battery pack to the XRX receivers.
  - The XRX receivers switch on.
  - The **RF status LEDs** **5** light up in **red**.

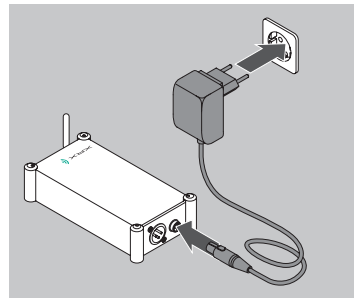

The **RF status LED** **5** on the XRX receivers change from **red** to **green** when the link has been established.

### □ Completing the linking process

- ▶ Briefly press the **Mute/Link button** **4**.
  - The **status LED** **7** switches from flashing **green** and lights up permanently in **green**.
  - The linking process is completed.

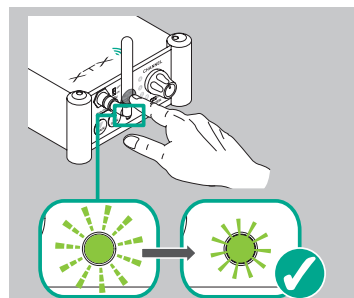

The XIRIUM X system is now ready for use.

## ■ Dual channel or stereo transmission with repeater

To overcome obstacles or enhance the reception reliability with diversity, one XRX device is used in repeater mode.

If a second XTX device is used as a slave, it is also possible to transmit stereo or two mono signals through the repeater.

The XTX master sends the audio signal on audio channel **M**. The XTX slave sends an audio signal on audio channel **2**. The repeater receives both audio signals and sends them separately to the XRX receivers.

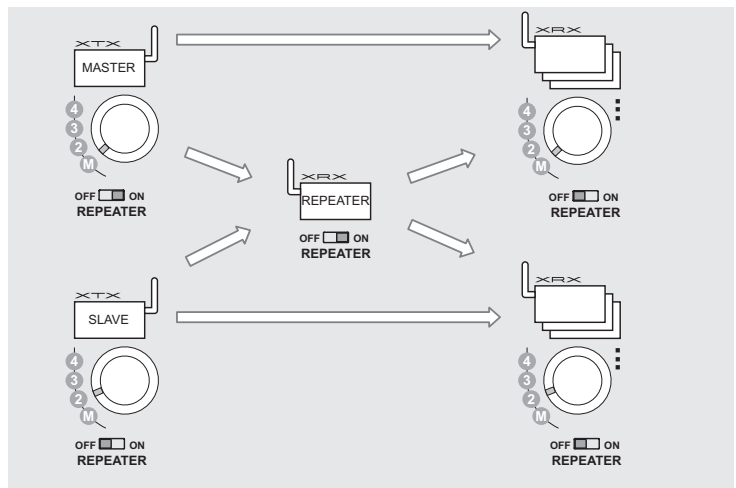

### — For this installation you require:

Necessary devices and components

- One XTX device as master
- One XTX device as slave
- One XRX device as repeater
- Any number of XRX devices as receivers
- One antenna for each XIRIUM X device.
- Two audio sources with a suitable connection cable
- One audio sink for each XRX device with a suitable connection cable

### ▣ Mounting the antennas

- ▶ Select the correct antennas for your configuration.
- ▶ Mount an antenna on each XIRIUM X device.
- ▶ Align the XIRIUM X devices and antennas.

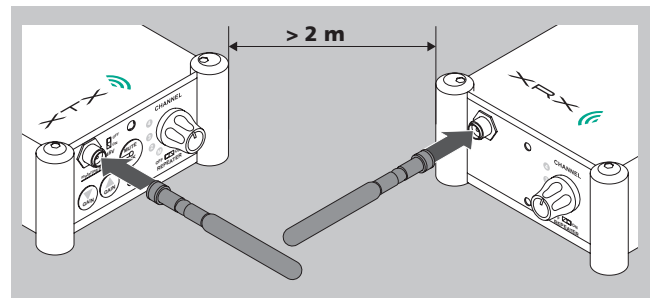

### ▣ Setting the Repeater switches

- ▶ Slide the **Repeater switches** **6**, **4** on the XTX device and on an XRX device to **ON**.
  - The XTX device is then the master.
  - This XRX device is then the repeater.

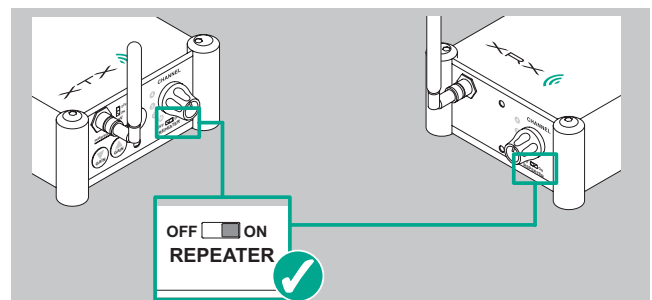

- ▶ Set the **Repeater switches** **4** on all other XRX devices to **OFF**.
  - These XRX devices are then XRX receivers.

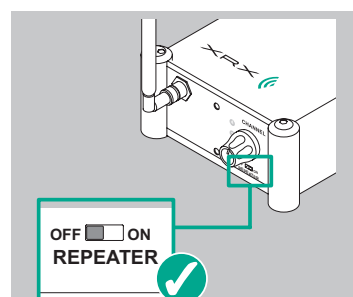

- ▶ Slide the **Repeater switch** **6** on the second XTX device to **OFF**.
  - This XRX device is then the XTX slave.

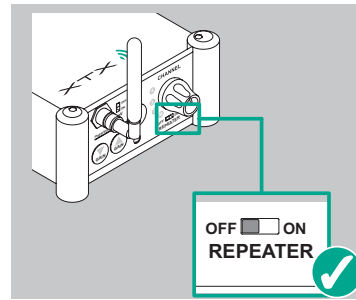

## ▣ Selecting the audio channels



If a repeater is used, the number of usable audio channels is limited to two.

### — XTX master

- ▶ On one XTX device set the **Channel select dial** **5** to **M**.
  - This XTX device has the master function.

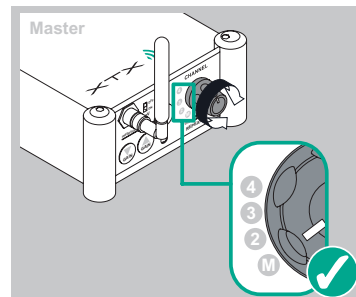

### — XTX slave

- ▶ On the XTX slave set the **Channel select dial** **5** to **2**.
  - The XTX slave sends audio signals on audio channel **2**.

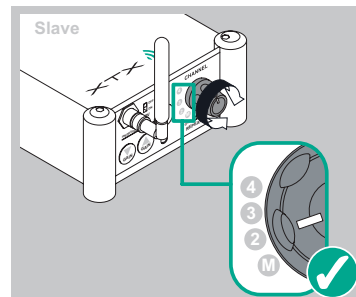

### — XRX receivers

- ▶ On the XRX receivers that should receive audio signals from the XTX master set the **Channel select dial** **3** to **M**.
  - The XRX receivers receive audio signals on audio channel **M**.
- ▶ On the XRX receivers that should receive audio signals from the XTX slave, set the **Channel select dial** **3** to **2**.
  - The XRX receivers receive audio signals on audio channel **2**.

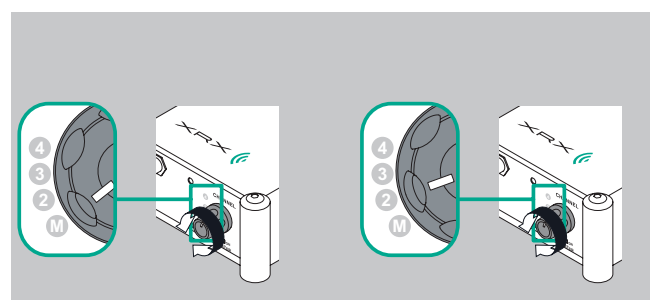

## ▣ Supplying power to the XTX master

- ▶ Connect a power supply or a XIRIUM X battery pack to the XTX master.
  - The XTX master switches on.

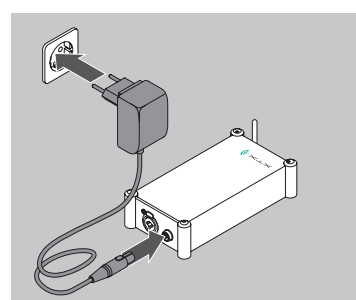

**Starting the linking process**

- ▶ Press the **Mute/Link button** **4** on the XTX master for two seconds until the **status LED** **7** lights up briefly in **orange**.
  - The **status LED** **7** flashes in **green**: The linking process is then initiated.

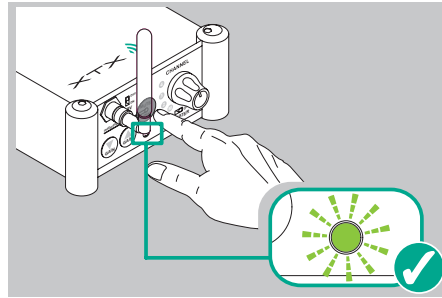

**Supplying power to the repeater**

- ▶ Connect a power supply or a XIRIUM X battery pack to the repeater.
  - The repeater switches on.
  - The **repeater LED** **2** flashes in **green**.

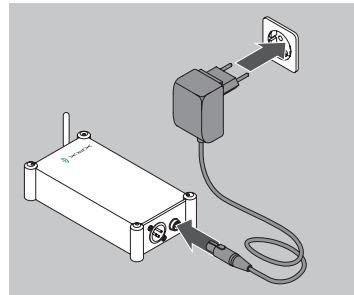

**!** The **RF status LED** **5** on the repeater changes from **red** to **green** when the link has been established.

**Supplying power to the XTX slave and XRX receivers**

- ▶ Connect the power supplies or XIRIUM X battery packs to the XTX slave and the XRX receivers.
  - The XTX slave and XRX receivers switch on.

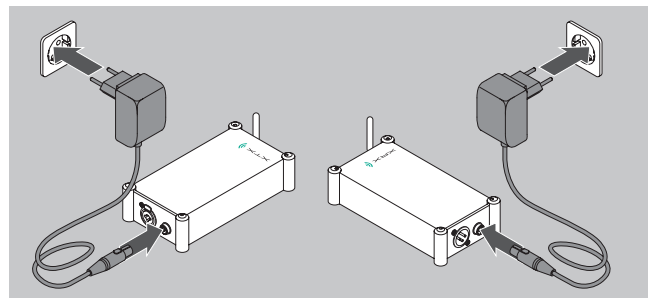

**!** The **status LED** **7** on the XTX slave and the **RF status LEDs** **5** of the XRX receivers switch from **red** to **green** when a link has been established.

**Completing the linking process**

- ▶ Briefly press the **Mute/Link button** **4**.
  - The **status LED** **7** switches from flashing **green** and lights up permanently in **green**.
  - The linking process is completed.

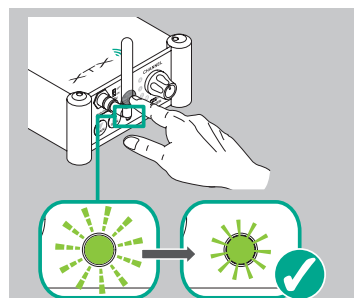

The XIRIUM X system is now ready for use.

## F Control options

### ■ Mute/Link button on the XTX device

The Mute/Link button **4** can be used to make various settings or display settings.

Mute/Link button <b>4</b>	Function
Press briefly.	Mute / unmute the device
Press for two seconds until the <b>status LED</b> <b>7</b> lights up briefly in <b>orange</b> .	Start the linking process
Press for four seconds until the <b>status LED</b> <b>7</b> lights up briefly in <b>red</b> .	Displaying the audio signal level
Press for six seconds until the <b>status LED</b> <b>7</b> lights up briefly in <b>green</b> .	RF channel indication
Press for eight seconds until the <b>green</b> light goes out.	Change the RF channel

### ■ Muting the audio signals

Every audio channel between an XTX and an XRX device can be individually muted.

- ▶ Briefly press the **Mute/Link button** **4** on the XTX device.
  - The XTX device is then muted.
  - All XRX devices that are in broadcast mode are also muted.
- ▶ Briefly press the **Mute/Link button** **4** again.
  - The mute function of the XTX device and all XRX devices that are in broadcast mode is cancelled.

### ■ Linking process

#### — Starting

- ▶ Press the **Mute/Link button** **4** for two seconds.
  - The **status LED** **7** lights up in **orange**.
- ▶ Release the **Mute/Link button** **4**.
  - The **status LED** **7** flashes in **green**.

#### — Finish

- The links to the XRX devices were established.
- The **RF status LED** **5** on the XRX devices lights up **green**.
- ▶ Briefly press the **Mute/Link button** **4**.
  - The linking process is completed.



The linking process is finished automatically after 10 minutes if it is not finished with the **Mute/Link button** **4**.

### ■ Displaying the audio signal level

You can have the volume level of the device indicated.

- ▶ Press the **Mute/Link button** **4** for four seconds until the **status LED** **7** lights up in **red**.
  - The **status LED** **7** shows the volume level.

Status LED	Audio signal level
—	< 40dBFS
<b>green</b>	≥ 40 dBFS
<b>orange</b>	≥ 18 dBFS
<b>red</b>	≥ 3 dBFS





The level indication remains active for 10 minutes before it is automatically cancelled. To cancel the volume indication manually, briefly press the **Mute/Link button** **4**.



## ■ Displaying the RF channel



You can also have the RF channel currently in use indicated by the **status LED** .

- ▶ Hold down the **Mute/Link button**  for four seconds until the **status LED**  lights up in **green**.
  - The **status LED**  shows which RF channel is in use.

Status LED	RF channel
Flashes once in <b>red</b>	36
Flashes twice in <b>red</b>	40
Flashes three times in <b>red</b>	44
Flashes four times in <b>red</b>	48

## ■ Selecting the RF channel

The XTX devices are set to RF channel 36 when they leave the works. The RF channel can be changed manually.

- ▶ Press the **Mute/Link button**  until the **green status LED**  goes out.
  - The XTX device switches from the currently set RF channel to the next higher channel.



The selected RF channel remains programmed, even if the XTX device is switched off.





## G Antenna Guide

This guide is provided as a brief overview of the antennas, their directionality and installation versions so that you can use these according to your requirements and use alternative options in the event of drop outs.

Stable wireless transmission starts with the selection of the right antennas for the respective setup. The supplied rod antennas cover a range of 360° (on the transmission and reception ends). The wavelengths in the 5-GHz range are very short but very suitable for transmission, as they are easily reflected by walls.

### ■ Radiation pattern

Every antenna has a specific radiation pattern. This pattern, also referred to as the directional radio pattern, determines the orientation of the antenna. The directional radio pattern is normally shown in polar coordinates as a polar diagram. There are omnidirectional antennas and directional antennas. While an omnidirectional antenna radiates over a range of 360° (as the name suggests), a directional antenna has a specific preferred direction. The “dBi”, the so-called gain of an antenna, indicates how many times stronger the signal in this preferred direction is than with a comparable antenna (isotropic antenna).

Section “Neutrik antenna range” on page 28 contains an overview of our range of antennas.

### ■ Diversity technology

When electromagnetic waves are radiated, the same problem occurs as with sound waves. The signal does not only reach the receiver on a direct path, but also by means of reflections from the wall, floor etc. In contrast to the direct signal, phasing of the reflected signals is shifted. As a result, overlapping signals cancel one another at various points in the room. For this reason two antennas are often used on the receiving end. If one antenna is in a dead zone, the signal of the second antenna can be used. This increases the transmission reliability considerably.

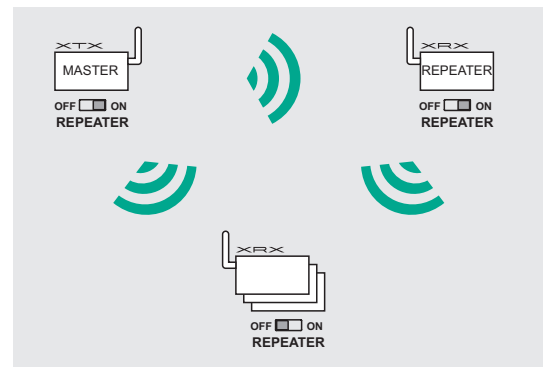

As two transmission and receiver units are used when a repeater is employed, this can be regarded as an extended true diversity – “extended” as the repeater can be placed in an optimised position.

The **diversity technology** can, however, also be implemented on the transmitter end. On the **XIRIUM X system** the additional use of a repeater ensures such a diversity setup and is aimed at keeping the radio transmission stable. The master transmits to both the repeater and the receiver. The repeater receives this signal and forwards it to the receiver so that two signals arrive at the receiver, and the strongest signal is used. To this purpose we recommend keeping the path between the XTX master and the repeater free from obstacles. Make sure the repeater is in a secure position.

## ■ Antenna selection

In rooms with a wide range of reflection options we recommend using the supplied NXA-3-360 rod antennas (omnidirectional antennas). If you have placed the XRX at a place where signals are cancelled, it is often sufficient to move the device a few centimetres to reach a reliable zone. Alternatively, an additional repeater can be positioned in such cases that enables a diversity setup and thereby increases the transmission reliability. To increase the range and also the stability, we recommend using directional antennas on the receivers (NXX1RX-T). The opening angle (horizontal) of our directional antennas ranges from 40° to 60°.

The RF signal is received more strongly inside this opening angle and the range is increased, and interference signals outside this angle are reduced at the same time.

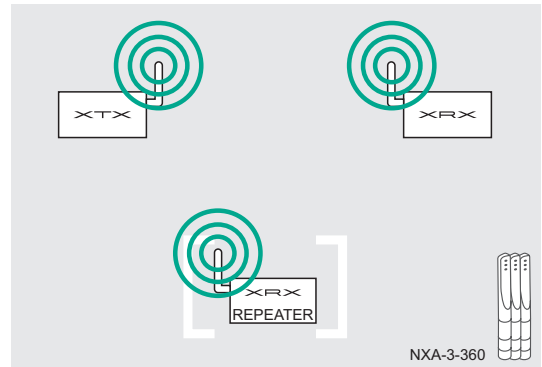

In the event of longer distances, we recommend switching to directional antennas and establishing a point-to-point link.

The directional antenna can be either screwed on with a suitable antenna cable or also directly on the receiver with an SMA adapter. The latter setup strengthens reception, as the signal remains unaffected by cable attenuation.

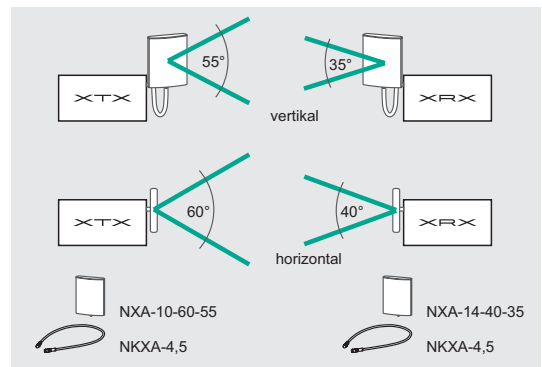

! On antennas with a higher gain than that of the supplied 2.3-dBi omnidirectional antennas that are mounted directly on the device:  
 ▶ Only use antennas with the NXX1RX-T receiver if it is **NOT** in repeater mode.

! With the NXX1RX-T receiver (in repeater mode) and the NXX1TX-T transmitter (in all operating modes):  
 ▶ Ensure that the correct antenna cable (refer to the table: "Recommended antenna/cable combinations" on page 26) is used between the device and the receiver.  
 Only then can compliance with the permitted values of the directives be ensured.

## ■ Recommended antenna/cable combinations

Antenna type		NXA-10-60-55	NXA-10-360-10	NXA-14-40-35
Cable type	Cable length (m)			
NKXA - 4.5	4.5	•	•	–
NKXA - 8	8	•	•	–
NKXA - 12	12	–	–	•
NKXA - 15	15	–	–	•
NXA-SMA-MM	Adapter	•*	–	•*

\* Only with XRX (if repeater mode is switched off).

## Alignment

For reliable transmission in the 5-GHz range we recommend a parallel antenna configuration with a line of sight (LOS).



The omnidirectional antenna NXA-10-360-10 is only omnidirectional in a horizontal direction. In a vertical direction it has a concentrated 10° beam.

► Position the omnidirectional antenna at the same height as the receiving antenna.

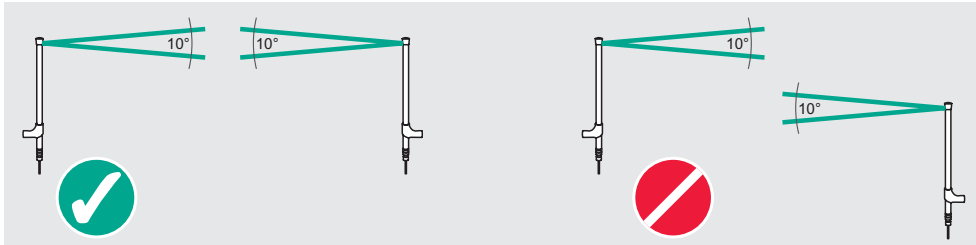

If the antennas are positioned above the heads of the audience, you prevent absorption of the electromagnetic waves by their bodies. Remember that around 75 per cent of the human body is water and it therefore absorbs the waves very well.

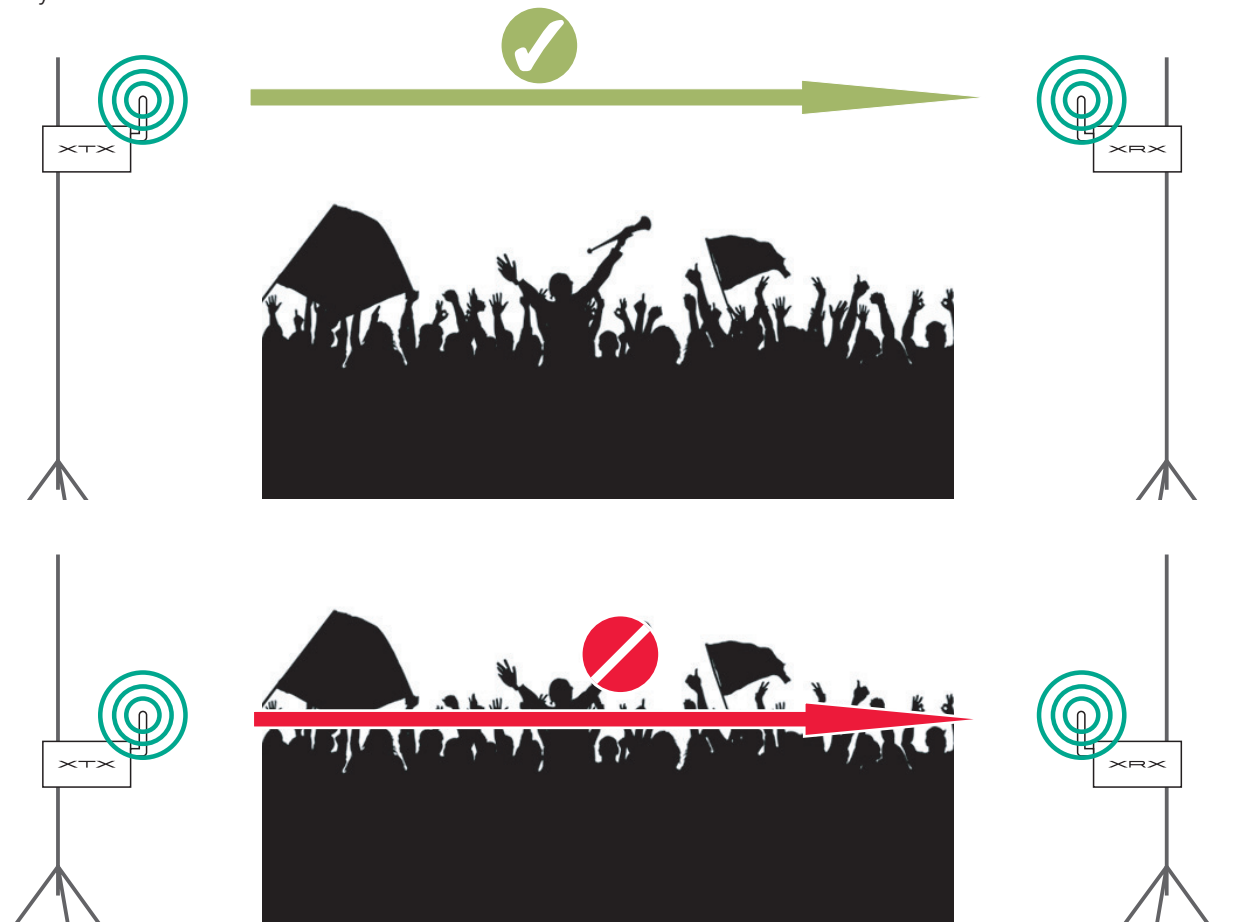

Antennas absorb the energy of an electromagnetic wave. If several receivers (antennas) are positioned too close to one another, both antennas receive less energy and the strength of the reception signal decreases.

In addition there should not be any objects within a range of 15 cm around the antenna. This distance should be even greater around metal objects.



## ■ Propagation of electromagnetic waves

The electromagnetic waves are susceptible to several forms of interference. These include the following:

### Reflections

Electrically conductive surfaces act as a mirror for electromagnetic waves. The following applies:  
The angle of incidence is the same as the angle of reflection.

### Absorption

In this case some of the electromagnetic waves are absorbed by the medium and converted into heat.

### Diffraction

Diffraction occurs, for example, on grids, in gaps and on edges. If multiple diffractions occur on grids, interference occurs.

## ■ Neutrik antenna range

### ▣ Omnidirectional antennas

— NXA-3-360 / 5-GHz antenna with 2.3 dBi gain

Radiation pattern:

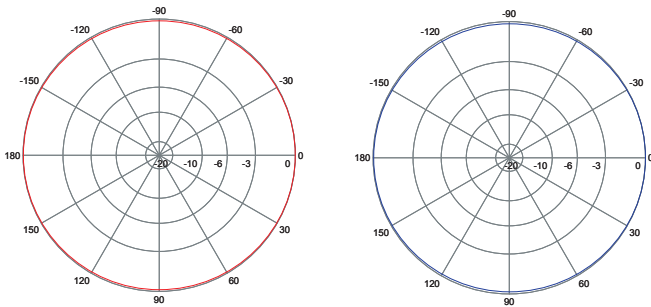

Horizontal: 360°      Vertical: 360°  
Antenna radiates in all directions (red circle).

— NXA-10-360-10 / 5-GHz antenna with 10 dBi gain

Radiation pattern:

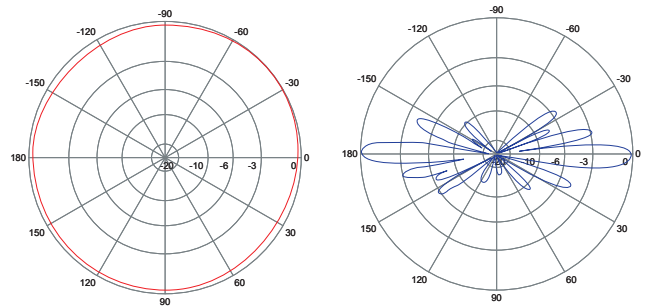

Horizontal: 360°      Vertical: 10°

### ▣ Directional antennas

— NXA-10-60-55 / 5-GHz antenna with 10 dBi gain

Radiation pattern:

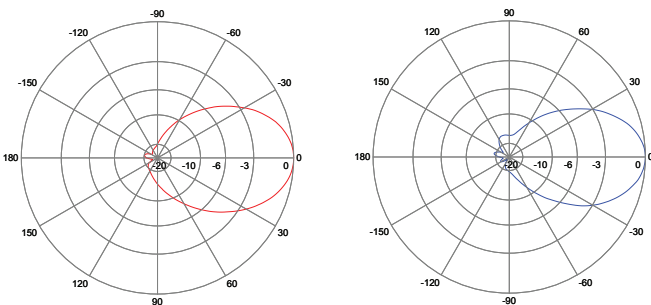

Horizontal: 60°      Vertical: 55°

— NXA-14-40-35 / 5-GHz antenna with 14 dBi gain

Radiation pattern:

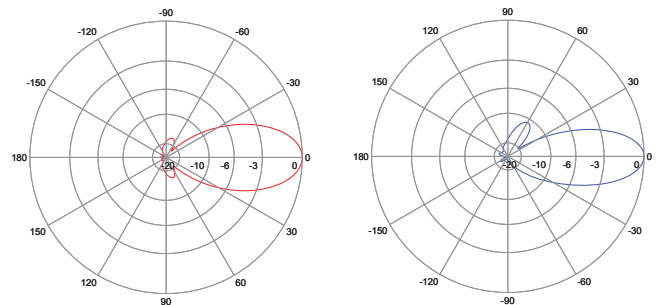

Horizontal: 40°      Vertical: 35°



## H After operation

### ■ Discontinuing operation and disassembly

- ▶ Remove the XIRIUM X battery packs from the XIRIUM X devices.
- ▶ Disconnect all XIRIUM X devices from the power supply and remove the mains connector from the power socket.
- ▶ Disconnect all cables connected to the XIRIUM X devices.
- ▶ Dismantle the antennas from the XIRIUM X devices.

### ■ Transport

- ▶ Only transport the devices and all accessories in the original packaging.

### ■ Storage

- ▶ Disconnect the XIRIUM X devices from the power supply and remove the mains connector from the socket if you do not use the XIRIUM X devices for a prolonged period of time.
- ▶ Remove the XIRIUM X battery packs from the XIRIUM X devices if you do not use them for a prolonged period of time.
- ▶ Keep all the XIRIUM X devices and all accessories in the original packaging.
- ▶ Store the XIRIUM X devices in a clean, dry place. Protect the XIRIUM X devices against dirt, dust, heat, moisture and liquids.

### ■ Care and cleaning

**CAUTION!** Risk of damage to the devices and the accessories if cleaned incorrectly!  
▶ Never immerse the devices and accessories in water.

- ▶ Remove the XIRIUM X battery packs from the XIRIUM X devices.
- ▶ Disconnect the XIRIUM X devices from the power supply.
- ▶ Clean the surfaces of the XIRIUM X devices and accessories with a soft, slightly damp cloth. If necessary use a small amount of washing up liquid.
- ▶ Ensure that no moisture or liquids penetrate inside the XIRIUM X devices.
- ▶ Never use any chemical cleaning agents.
- ▶ Do not use any materials (such as cleaning cloths with a rough surface) that can scratch the surface.

### ■ Servicing and repair

The XIRIUM X devices do not contain any parts that you can service or repair yourself.

- ▶ Check the XIRIUM X devices regularly for any visible damage to the housings, controls, cables and connectors.
- ▶ Do not use the XIRIUM X devices if any damage is visible. Disconnect the XIRIUM X devices from the power supply.
- ▶ Replace defective cables and accessories immediately.

### ■ Disposal



- ▶ Dispose of the XIRIUM X devices and the accessories in accordance with locally valid regulations.
- ▶ Do not dispose of electrical devices and accessories such as cables, connectors, power packs and components in domestic waste.

- ▶ Dispose of the packaging and packaging items in accordance with locally valid regulations.
- ▶ Dispose of the plastic, metal and other recyclable materials in accordance with the locally valid recycling regulations.



## Operation from the computer

The **XIRIUM X Companion** software can be used to control the XIRIUM X device functions from a computer. The software can be downloaded free of charge from the NEUTRIK website.

<http://www.neutrik.com>

### Installing the XIRIUM X Companion

**!** When installing the software on your computer, observe the instructions regarding the required hardware and operating system of your computer.

#### System requirements

Computer with the operating system Microsoft Windows XP / Microsoft Windows 7 / Microsoft Windows 8 / Mac OSX. The screenshots are valid for Windows operating systems.

#### Download

- ▶ Download the **XIRIUM X Companion Setup** zip file from the website and save it on your computer.
- ▶ Unzip the file on your computer.

#### Installing the software

- ▶ Double-click the **XIRIUM X Companion Setup** icon.
  - The main window opens.

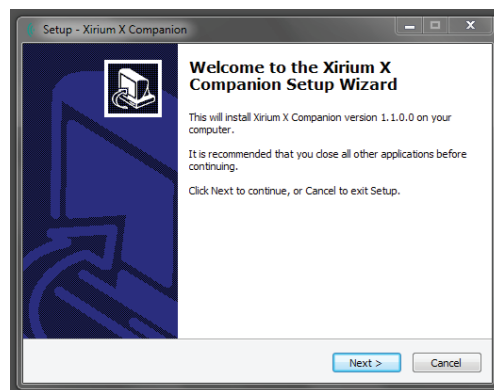

- ▶ Click on **Next**.
- ▶ Now select where you want to save the **XIRIUM X Companion** software.

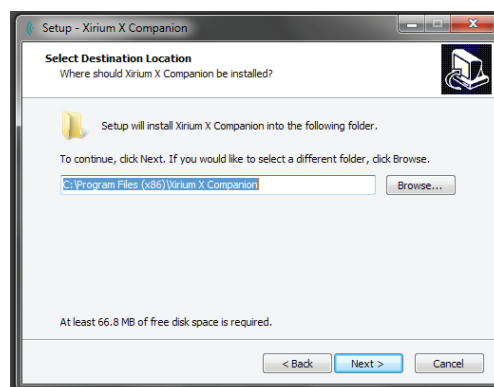

- ▶ Follow the individual installation steps.
- ▶ After installation the browser opens. Enter your name and e-mail address to receive regular information on updates in our newsletter.
  - The **XIRIUM X Companion** icon appears on the computer desktop.

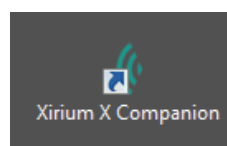

- ▶ Depending on your system, you may have to install the "CP210x USB to UART bridge driver" so that the XIRIUM X Companion can recognise the connected devices. This driver is also included in the Companion X zip folder on our website.



## ■ Using the XIRIUM X Companion

### □ Starting the program

- ▶ Click the **XIRIUM X Companion** icon.
  - A message appears.
 

“Please wait for the device to start up completely before trying to control it with the Xirium X companion.” Confirm this message with OK.
- ▶ A connected XTX master must first light up in green before it can be accessed with the XIRIUM X Companion.
- ▶ The green LED must also light up with previously associated XTX slaves and XRX clients.
- ▶ Non-associated devices light up continuously in red but can still be controlled with the XIRIUM X Companion.
  - The main window opens.
- ▶ Click **Refresh** to ensure that the display of the XIRIUM X devices is updated.

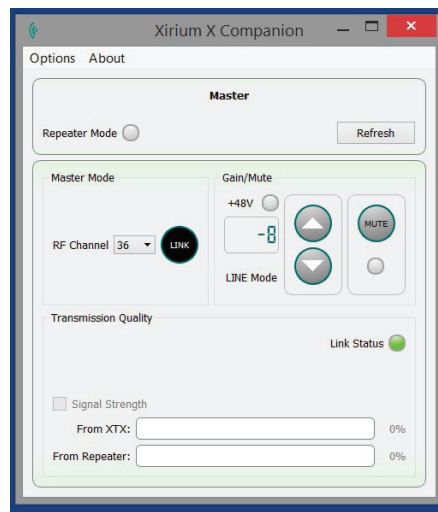
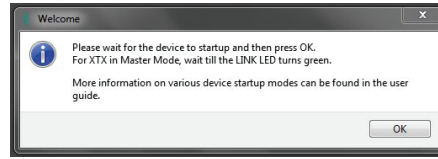

### □ Software structure

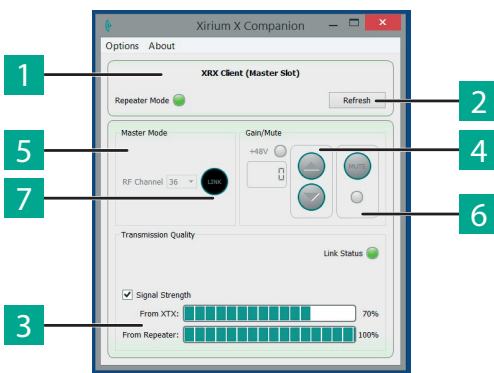

Item	Designation	Explanation
1	<b>Device Info</b>	Name of the connected XRX device
2	<b>Refresh button</b>	Refresh the display of the XRX device
3	<b>Signal Strength</b>	Signal strength of the XTX device and the repeater if applicable when an XRX device is connected
4	<b>Audio Gain</b>	Gain, can be adjusted in 1-dB steps
5	<b>Master Mode</b>	Select the radio channel
6	<b>Mute button</b>	Mute the audio channel that is in use
7	<b>Link button</b>	Start a link between the units



▣ **Menu bar**

Menu / sub-menu	Explanation
<b>Options</b>	Select an option
<b>Refresh</b>	Refresh the display of the connected device
<b>Device Version</b>	Information on the used firmware
<b>Firmware Update</b>	Update the firmware
<b>About</b>	Information and registration
<b>Info</b>	Show the software version
<b>Register</b>	Online registration for software and information on firmware updates
<b>Service Mode</b>	Service function (reserved for the manufacturer)

▣ **Firmware Update**

**!** Ensure that the wireless connection is deactivated when the firmware is updated. All other devices except the connected unit must be switched off.

▶ First download the current firmware from the website as a zip file and save it on your computer.

▶ Start the program.

▶ In the **Options** menu select the item **Firmware Update**.

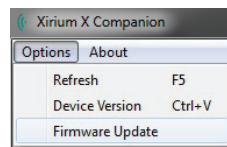

• The **Firmware Update** window appears.

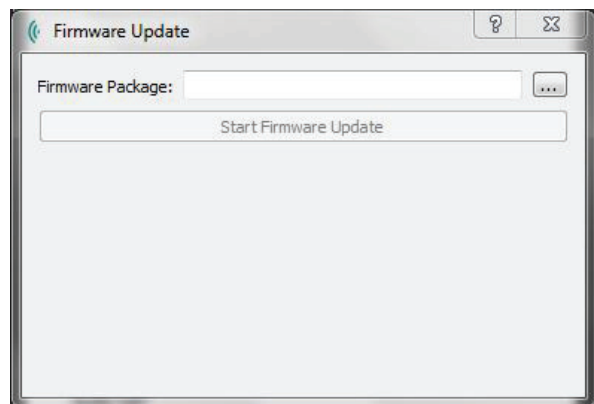

▶ In the **Firmware Package** field select where you want to save the zip file on your computer. (It is not necessary to unzip the zip file).

▶ Click **Start Firmware Update**.

- Installation runs automatically.
- A confirmation message appears.

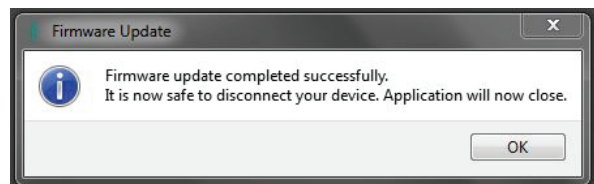

▶ Click **OK** and close the window by clicking on the **x** in the top right-hand corner of the window.

▶ Disconnect the XIRIUM X device and reconnect it.

▶ Start the **XIRIUM X Companion software** (refer to “Starting the program” on page 31).

- In the main window the current firmware of the XIRIUM X device is displayed in the **Device Info** field.
- **The update is then finished.**







## ▣ Closing the program

- ▶ Click on the **x** in the top right-hand corner of the main window.
  - The program is then closed.

## ▣ Deinstalling the software

- ▶ Deinstall the software by using the deinstallation function of your operating system.

# J Service

## ■ Contact

- ▶ Please contact your dealer or NEUTRIK if you have any questions concerning your device.
  - Addresses are given overleaf.

## ■ Troubleshooting

- ▶ Please contact your dealer or NEUTRIK if you have any questions concerning your device.
  - Addresses are given overleaf.

## ■ Conformity declaration

The conformity declaration is available for downloading from the NEUTRIK website.



## K Technical data

Please refer to the “XIRIUM X Technical Information” data sheet for further information.

### — GENERAL SPECIFICATIONS

Radio frequency carrier range	IEEE 802.11a, 5.15 – 5.25 GHz, channels 36 – 48, licence-free
Data protocol	proprietary (DIWA technology)
Transmit power	ETSI compliant
Range	Up to 500 m point to point (LOS). Longer range depending on obstacles, reflections, interferences

### — AUDIO PERFORMANCE (ANALOG TO ANALOG PER WIRELESS LINK)

THD + Noise (TX Gain = min.)	< 0.01% @ 1 kHz, 4 dBu / < 0.05% @ 20 Hz – 10 kHz, 4 dBu
Frequency Response	+0.5 dB / –1.5 dB @ 20 Hz ... 20 kHz ref. 1 kHz
Dynamic Range	> 105 dB @ 1 kHz, A-weighted
Crosstalk	< –90 dB @ 20 kHz
Number of audio channels	Up to 4 TX possible, each with a separate audio channel
Broadcast mode (RX only)	Unlimited number of XRX clients
Converter Resolution (AD & DA)	24 bit
Sampling Rate	48 kHz
Latency (Delay)	3.3 msec
Transmission method	Compression-free, no reduction of converted data
Operating Temperature	0°C to +50°C
Storage Temperature	–20°C to +80°C



**— XTX SPECIFIC CHARACTERISTICS**

Antenna	1 x 1/2 wave dipole with SMA male connectors
Number of audio channels	1
Phantom Power (when activated)	48 V DC / 7 mA

**— ANALOG INPUT SPECS:**

Input Mode	Input Level						
	Input Imp. kOhm	Rated Source Imp. Ohm	Sensitivity* dBu	Max.** dBu	Gain dB	Phantom Switch	Connector type
Line (balanced)	10	1000	-36	+22	0..40	OFF	Combo XLR, TRS
Mic (balanced)	2.5	200	-68	+1	21...75	OFF	Combo XLR, TRS
Mic Phantom Power (balanced)	2.1	200	-68	+10	12, 20...75	ON	Combo XLR
Hi-Z (unbalanced)	2200	150000	-50	+8	10, 18...54	ON	Combo TRS
Indicators	LEDs:	Mute Status / Linking Process / Metering / RF channel view / RF channel switch / 48 V, Impedance View					
Controls	Phantom / Hi-Z enable switch / Repeater switch, Gain, Channel select, Mute						
Power Supply	5 V DC / 2 A via Mini-XLR connector (4 pole male) or Battery-Pack NXBP-T-6						
Dimensions (w x h x d)	178 mm x 78 mm x 41 mm (excluding antenna)						
Weight	520 g						
Optional Accessories	Antenna + cable extension, battery pack, mounting clamp						
* Sensitivity corresponds to value where a nominal output voltage is achieved at maximum gain setting.							
** Maximum input level corresponds to value where almost signal clipping occurs at minimum gain setting.							
0 dBu = 0.775 V rms							



— **XRX SPECIFIC CHARACTERISTICS**

Antenna	1 x 1/2 wave dipole with SMA male connectors
Number of audio channels	1

— **ANALOG OUTPUT SPECS:**

Output Type	Output Level				
	Output Imp. Ohm	Rated Load Imp. Ohm	Nominal dBu	Max. Level dBu	Connector type
Line Output (balanced)	800	10	-2	+16	XLR
Indicators	LEDs:	transmission quality, Mute, Repeater Mode			
Controls	Channel select, Repeater switch				
Power Supply	5 V DC / 2 A via Mini-XLR connector (4 pole male) or Battery-Pack NXBP-T-6				
Dimensions (w x h x d)	178 mm x 78 mm x 41 mm (excluding antenna)				
Weight	510 g				
Optional Accessories	Antenna + cable extension, Battery-Pack, Mounting Clamp, SMA Adapter				

— **OPTIONAL ANTENNAS – Linear polarised directional WI-FI antenna / Frequency band: 5.150 GHz - 5.875 GHz**

Type	NXA-10-60-55	NXA-10-360-10	NXA-14-40-35
Gain	10 dBi	10 dBi	14 dBi
Beam width horizontal	60°	360°	40°
Beam width vertical	55°	10°	35°
Connector	SMA jack	N incl. SMA connector	SMA jack
Dimension (mm)	101 x 80 x 20	24 x 630	101 x 80 x 35
Weight	0.13 kg	0.20 kg	0.11 kg
Operating temperature	-40°C to +80°C	-40°C to +80°C	-40°C to +80°C

— **BATTERY PACK**

Energy	33.3 Wh = 6.660 mAh
Operating time	12 h
Operating temperature	0 °C to +50 °C
Dimensions (w x h x d)	155 mm x 62 mm x 29 mm
Weight	254 g



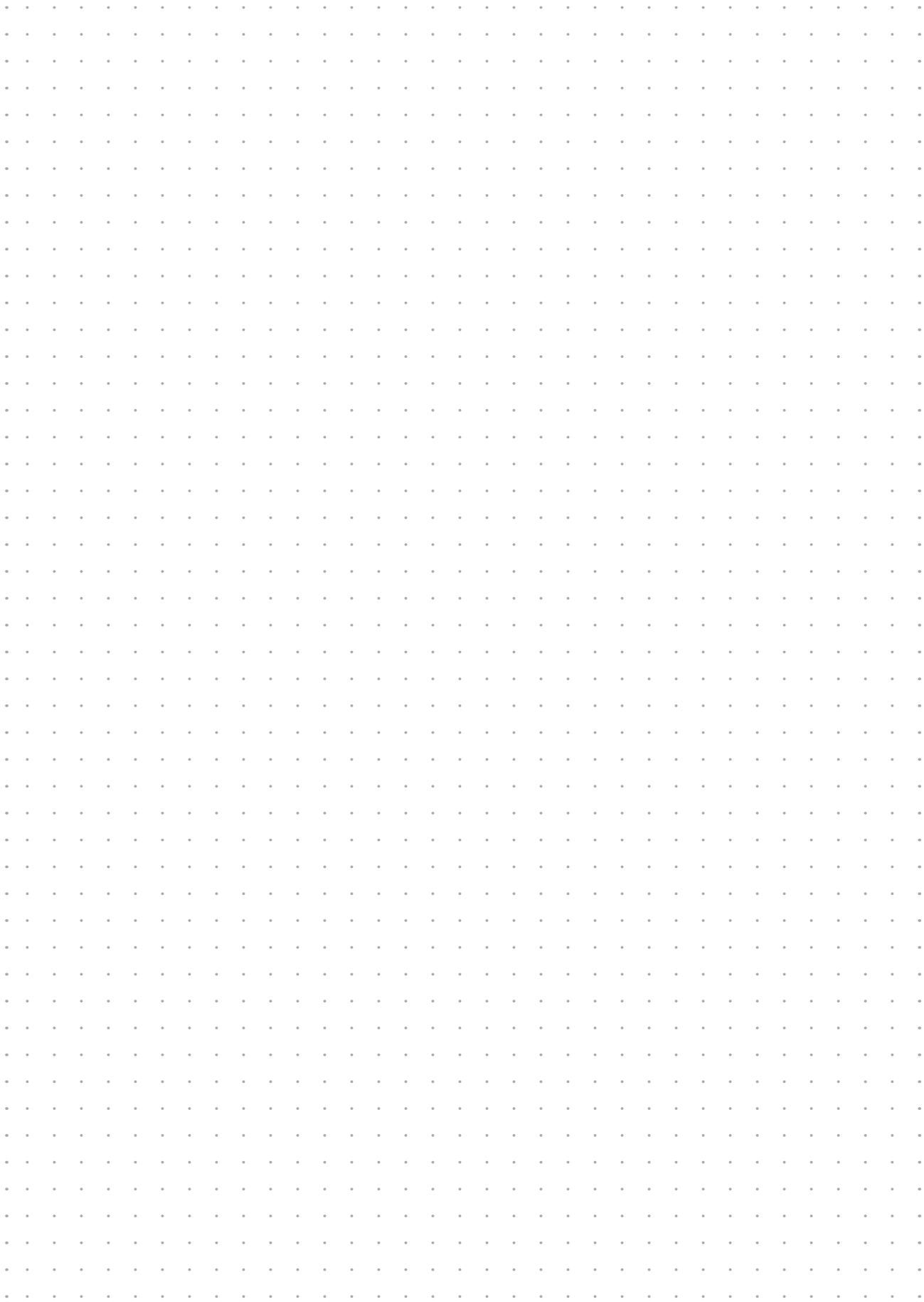



Technical data table grid (content is illegible due to low resolution).





Grid of technical data points (rows and columns).



#### Liechtenstein (Headquarters)

NEUTRIK AG, Im alten Riet 143, 9494 Schaan  
T +423 237 24 24, F +423 232 53 93, neutrik@neutrik.com

#### Germany /Netherlands /Denmark /Austria

Neutrik Vertriebs GmbH, Felix-Wankel-Strasse 1, 85221 Dachau, Germany  
T +49 8131 28 08 90, info@neutrik.de

#### Great Britain

Neutrik (UK) Ltd., Westridge Business Park, Cothey Way  
Ryde, Isle of Wight PO33 1 QT  
T +44 1983 811 441, sales@neutrik.co.uk

#### France

Neutrik France SARL, Rue du Parchamp 13, 92100 Boulogne-Billancourt  
T +33 1 41 31 67 50, info@neutrik.fr

#### USA

Neutrik USA Inc., 4115 Taggart Creek Road, Charlotte, North Carolina, 28208  
T +1 704 972 30 50, info@neutrikusa.com

#### Japan

Neutrik Limited, Yusen-Higashinohbashi-Ekimaie Bldg., 3-7-19  
Higashinohbashi, Chuo-ku, Tokyo 103  
T +81 3 3663 47 33, mail@neutrik.co.jp

#### Hong Kong

Neutrik Hong Kong LTD., Suite 18, 7th Floor Shatin Galleria  
Fotan, Shatin  
T +852 2687 6055, neutrik@neutrik.com.hk

#### China

Ningbo Neutrik Trading Co., Ltd., Shiqi Street, Yinxian Road West  
Fengjia Villiage, Yinzhou Area, Ningbo, Zhejiang, 315153  
T +86 574 88250488 800, neutrik@neutrik.com.cn

#### India

Neutrik India Pvt. Ltd., Level 3, Neo Vikram, New Link Road,  
Above Audi Show Room, Andheri West, Mumbai, 400058  
T +91 982 05 43 424, anklesaria@neutrik.com

#### Associated companies

##### Contrik AG

Steinackerstrasse 35, 8902 Urdorf, Switzerland  
T +41 44 736 50 10, contrik@contrik.ch

##### H. Adam GmbH

Felix-Wankel-Straße 1, 85221 Dachau, Germany  
T +49 08131 28 08-0, info@adam-gmbh.de



[www.neutrik.com](http://www.neutrik.com)  
[www.xirium.net](http://www.xirium.net)