

Print Bohrplan Bestückungsseite
PCB-Layout (component side)

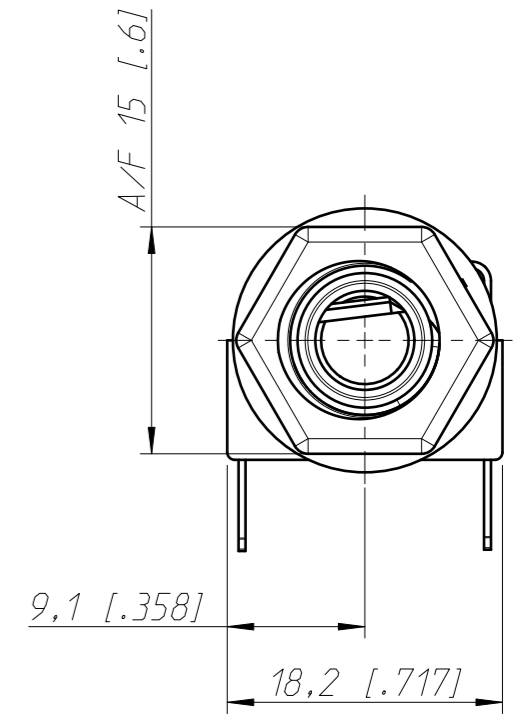

Frontplattenausschnitt (Rückseite)
Panel cut out (rear side)

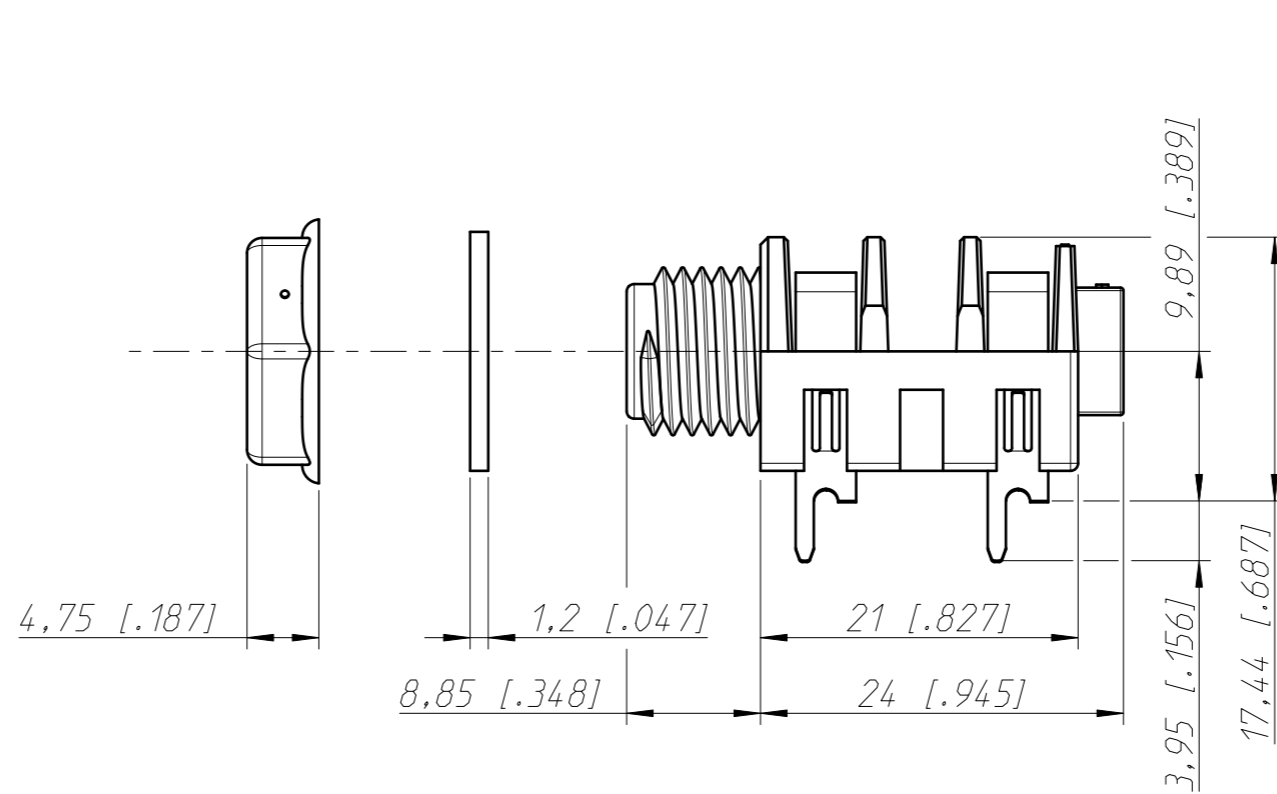
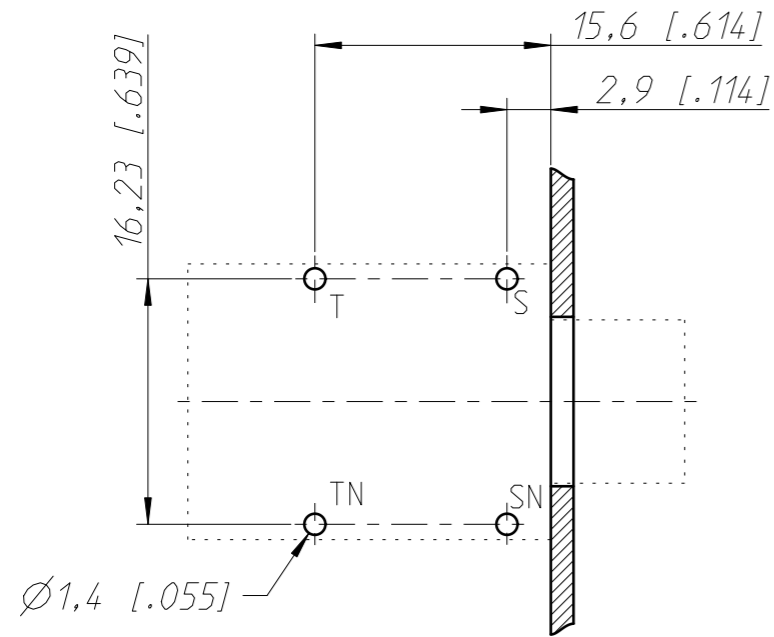
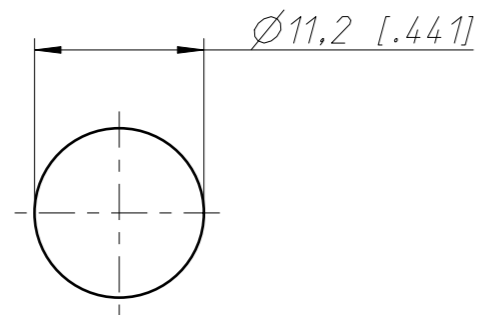

Sheet Number 1/1	Projection 	Scale 2:1	Format A3	Tolerancing ISO 2768-mK	
ECN Number -	Created 20.02.2003		noe		
Description NMJ4HFD3			Modified 22.02.2021		mmu
			Approved 23.02.2021		phk
			Status Released		
NEUTRIK		3D Model ID NMJ4HFD3	Document ID ST-NMJ4HFD3		Revision -