



ASSEMBLY INSTRUCTION

etherCON® | NE8MX6 & NE8MX6-B CAT6A Cable Connector

- Tools:**
- HX-CAT6A or pliers wrench
 - Wire cutter
 - Cable pulling lubricant

Cable O.D.: 7.0 - 9.5 mm (0.28 - 0.37")
Wire Size: AWG 26/1 - AWG 24/1 (solid)
 AWG 27/7 - AWG 24/7 (stranded)
Insulation Diameter: > 0.85 - 1.10 mm

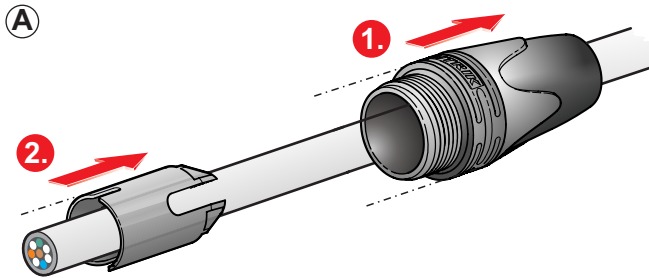

(A) Slide the boot (1.) and the chuck (2.) onto the cable.

To ease the boot assembly apply some cable pulling lubricant to the cable ends.

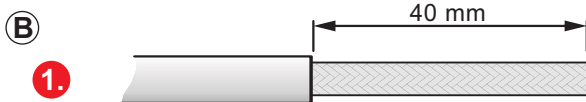

(B) 1. Prepare the cable as shown and strip the jacket at a length of 40 mm.

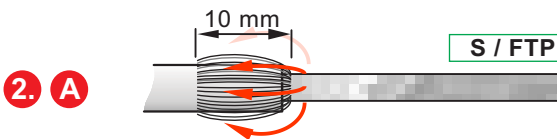

2. **A. S / FTP**
Cut off braided shield to approx 10 mm and fold the shield backwards.

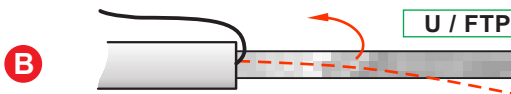

B. U / FTP
Remove the foil of the paired wires and bend back the drain wire for easier handling during assembly. Drain wire to be used for grounding.

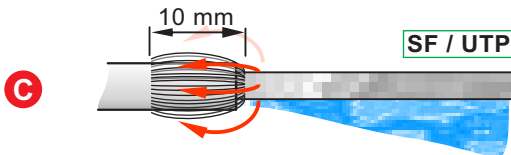

C. SF / UTP
Cut off braided shield to approx 10 mm and fold the shield backwards. Cut and remove the foil screen.

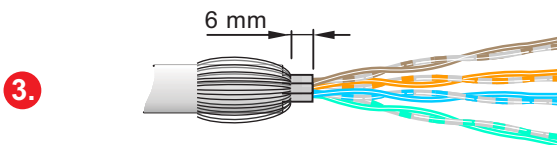

3. Remove the pair screening (if existing) to max. 6 mm.

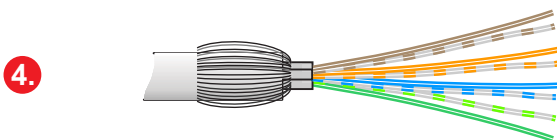

4. Presort, untwist and straighten the wires as shown. Unstraightened wires could potentially harm the IDC.

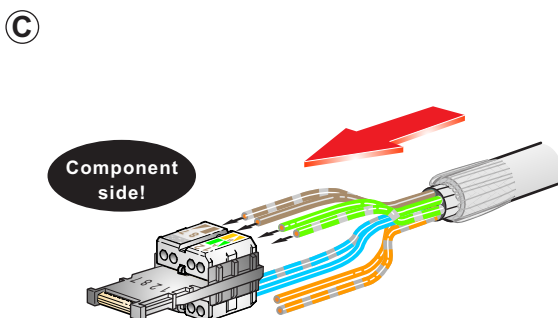

(C) Insert the wires into the designated position of the wire management as per below wiring scheme, either T568A or T568B

| Component side! | Connection | | RJ 45 PIN No. |
|-----------------|------------------|--------|---------------|
| | Color code T568A | T568B | |
| | W - G | W - O | 1 |
| | G | O | 2 |
| | W - O | W - G | 3 |
| | BL | BL | 4 |
| | W - BL | W - BL | 5 |
| | O | G | 6 |
| | W - BR | W - BR | 7 |
| | BR | BR | 8 |

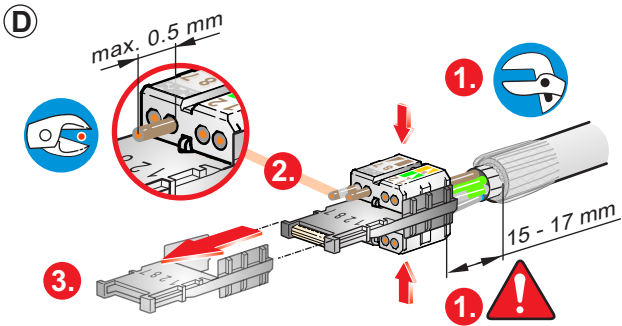

- D 1. Use HX-CAT6A or pliers wrench to press the wire management together.

Attention:
Distance between the cable jacket and the wire management shall not exceed 15 - 17 mm.

- 2. Cut all wires with a wire cutter. Allow wires to protrude max. 0.5 mm.
- 3. Remove the assembly guidance.

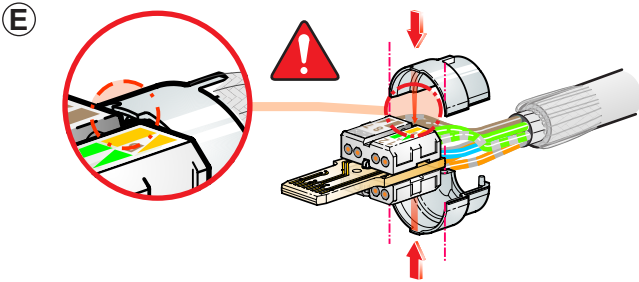

- E Position the ground-shells over the wires as shown.

Attention:
Align the coding nibs of the ground shells to the grooves in between the wire pairs in the wire management.

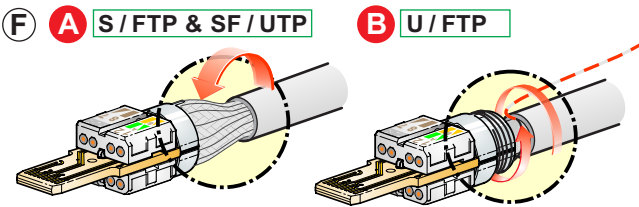

- F A. Put the cable-shield over the ground shell and distribute the shield wires circumferentially.
- B. Put the drain wire over the ground shell and wrap the drain wire circumferentially.

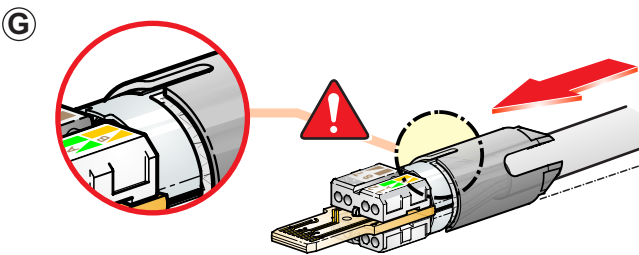

- G Slide the chuck over the cable-shield / drain wire and the ground shell towards the end-position.

Attention:
Align the slots of the chuck to the ribs of the ground shell.

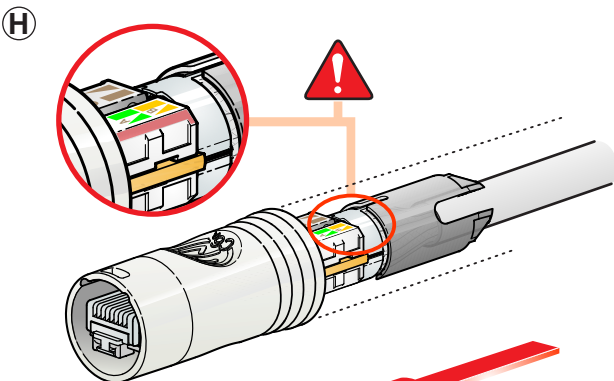

- H Slide the pre assembled cable (step G) into the housing.

Attention:
Align the side of the wire management with wire numbers 1/2, 8/7 to the side of the housing that has the Neutrik logo and the slot.

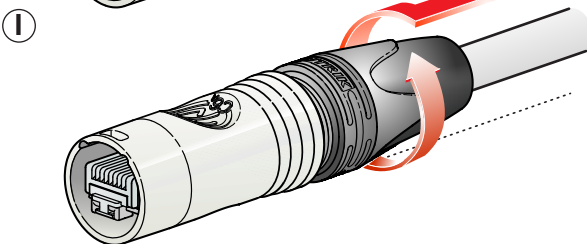

- I Finish the installation by turning the bushing onto the connector.

Option:
Use the handtool HTXX-14 to tighten the bushing.



Find more details of etherCON on www.neutrik.com.

Neutrik AG LI T: +423 / 237 24 24 F: +423/232 53 93
Neutrik USA Inc. USA T: +1 704 / 972 3050 F: +1 704/438 9202
Neutrik (UK) Ltd. UK T: +44 1983 / 811 441 F: +44 1983/811 439
Neutrik Vertriebs GmbH DE/NL/AT/DK T: +49 8131 / 280 890 F: +49 8131/280 830

Neutrik France FR T: +33 1/4131 6750 F: +33 1/4131 0511
Neutrik Tokyo Ltd. JP T: +81 3/3663 4733 F: +81 3/3663 4796
Neutrik Hong Kong Ltd. HK T: +852/2687 6055 F: +852/2687 6052
Neutrik India Pvt. Ltd. IND T: +91/982 05 43 424 F: +91/22 26163 540