

XIRIUM PRO



DIGITAL WIRELESS AUDIO SOLUTION
Designed for Europe

NEUTRIK

ELIMINATE CABLES KEEP PURE SOUND

ON/OFF
LINK push 1s
XROC push 4s

DWA
DIGITAL WIRELESS AUDIO



Regardless of the event, live sound, or house of worship: XIRIUM PRO provides the perfect audio solution. As a true replacement for cable bound systems it eliminates the often difficult and time consuming task of running cables.

NEUTRIK – the vision

The vision of a wireless transmission system between two connectors and to transmit audio signals in studio quality has led to the development of the innovative DiWA technology. DiWA (Digital Wireless Audio) provides license-free, compression-free, studio quality, full bandwidth audio with extremely low latency.

XIRIUM PRO – time and money saver

With XIRIUM PRO Neutrik introduces a new, innovative product, allowing for easy adoption of DiWA technology. With just two devices, namely the transmitter (TX) and the receiver (RX), audio transmission can be established quickly, and more cost effectively than using traditional audio cables or other wireless systems. Engineers, artists, and project designers can now think beyond the physical limitations of the traditional audio cable. Equipment such as loudspeakers, amplifiers, and mixing consoles can now be positioned for optimal audio performance and what makes the most acoustic sense allowing artistry and sonic performance to take priority over venue logistics.



XIRIUM PRO – up to 75 % time saving

Conventional installation with cable

INNOVATIVE TECHNOLOGY STUDIO SOUND QUALITY



With XIRIUM PRO, a digital wireless audio system based on DiWA technology, Neutrik sets a new standard in professional wireless audio transmission.

XIRIUM PRO – the product

XIRIUM PRO combines digital transmission facilitating the highest possible sound quality, reliability, and outstanding performance in one unique solution. Neutrik, known as the global leader in manufacturing connector technology for the professional entertainment industry, completes the innovation circle in audio connectivity, by providing solutions with copper connectors, fiber optic systems and now wireless solutions.

DiWA
DIGITAL WIRELESS AUDIO



PURE SOUND

- Superior audio quality
- 5 GHz band
- Digital Transmission



ROBUST TRANSMISSION

- Proprietary protocol
- Correction algorithm
- Repeater unit
- XROC
- Software App



PLUG & PLAY

- Easy setup
- Modular I/O concept
- Flexible power supply

MODULAR SYSTEM



... with 2 base units, 7 modules and the XIRIUM PRO software app

A XIRIUM PRO device consists of a TX (transmitter) or RX (receiver) base unit and an input or output module. XIRIUM PRO offers the greatest flexibility available in a wireless audio system today. In order to make this flexibility possible, XIRIUM PRO offers a combination of 7 different input and output audio modules and 2 base units. There are modules, for analog (line-level), digital (AES/EBU), Dante, as well as a repeater module (RX only). All the modules contain a rechargeable lithium-ion battery and can be operated either on battery power or on direct mains power. These modules can be mixed and matched within each base unit allowing for a signal conversion from one type of signal to another. No matter what the audio signal type, XIRIUM PRO can handle it.

INPUT	OUTPUT		
	ANALOG LINE	DIGITAL AES/EBU	DANTE
ANALOG LINE	✓	✓	✓
DIGITAL AES/EBU	✓	✓	✓
DANTE	✓	✓	✓



Base unit

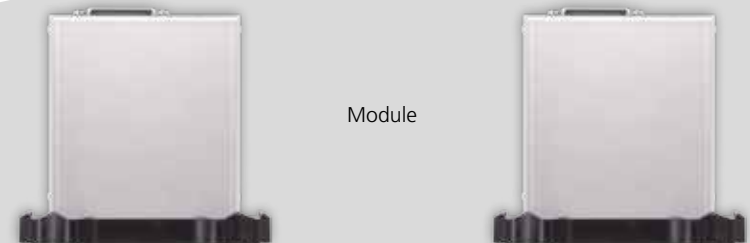

Module

SYSTEM COMPONENTS





SETTING STANDARDS

CRYSTAL CLEAR HIGHS AND FULL LOWS



The proprietary DiWA protocol provides 24 bit / 48 kHz sampling and enables the transmission of the entire audible frequency range from 20 Hz to 20 kHz.

Impressive technical data

DiWA provides 24 bit / 48 kHz sampling

Transmission: Compression-free, no reduction of converted data

THD: < 0.01 % @ 1 kHz

Dynamic range: > 105 dB @ 1 kHz, A-weighted

Crosstalk: < -80 dB @ 20 kHz

Number of audio channels @ 24mbps: 2

Number of audio channels @ 6mbps: 1 (XROC mode)

Latency (Delay): 3.6 msec

Frequency response: +0.5 dB / -1.5 dB @ 20 Hz – 20 kHz ref. 1 kHz

Audio transmission with the quality of a recording studio – without compression

With DiWA (Digital Wireless Audio) Neutrik has developed a technology for digital data transmission achieving high fidelity without data compression. A digital, uncompressed audio stream of 24 bit/ 48 kHz requires a bandwidth of 1,15 MHz. Such bandwidth can not be transmitted in the UHF band without using a compander. By choosing the 5 GHz band XIRIUM PRO provides 20 MHz bandwidth. Despite employing wireless technology, audio signals are transmitted at the level of quality found in a recording studio.

Frequency response

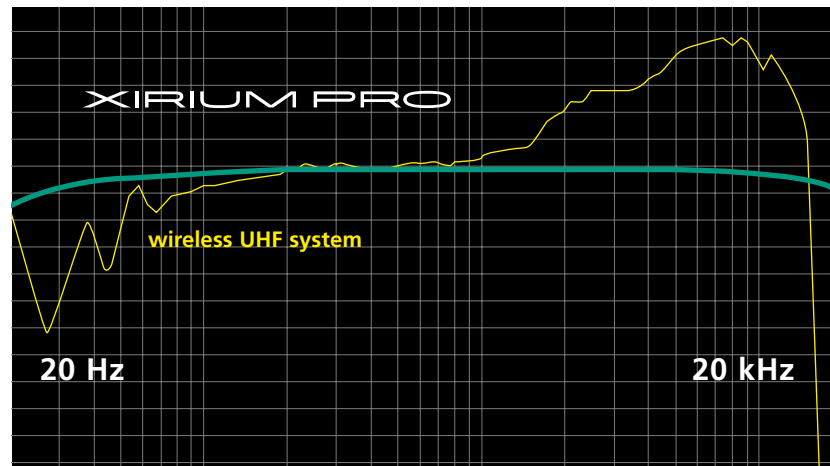

Bandwidth



DiWA
DIGITAL WIRELESS AUDIO

INTERFERENCE FREE TRANSMISSION



Using the 5 GHz band for transmission, XIRIUM PRO offers an alternative to the reduced availability of VHF/UHF channels and congestion found in the 2.4 GHz band.

Exceeding boundaries

The repeater is the perfect extension of the system: When used, the system range can be doubled, and walls, corners, or other obstacles may be overcome.

Extended true diversity for even more reliable reception

Since the repeater duplicates and forwards the signals received from the transmitter it becomes a second, redundant audio source for every receiver. Each receiver automatically selects the best signal and switches between them without interruption.

Channel occupation

The constant DiWA data flow prevents interference from other devices occupying the 5 GHz frequency band.





Reliable operation/Forward error correction

Specially developed and patented data protocols transmit redundant data packets assuring trouble-free transmission.

Using advanced error correction ensures uninterrupted signal reception, eliminating delays or loss of the audio transmission. In fact, as many as 17 data packets may be lost without harming the signal.

XROC (Extreme Ruggedized One Channel)

When RF congestion at a venue or event is at its worst, activate the exclusive Xirium Pro XROC feature and eliminate any opportunity for offending RF traffic to affect your wireless audio signal.

XIRIUM PRO software app

Available for iPad and Android tablets, the user friendly XIRIUM PRO app provides enhanced setup functions and allows monitoring and control of XIRIUM PRO devices.

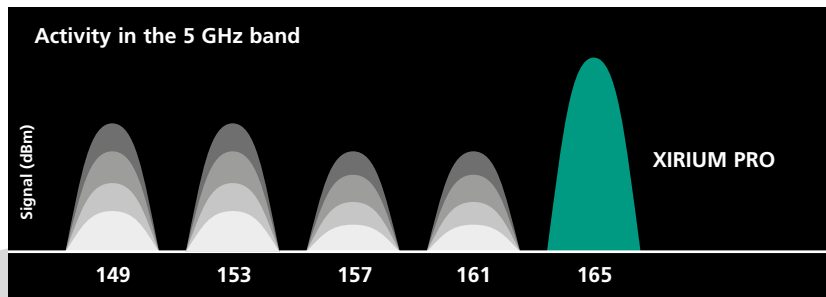

XIRIUM PRO SOFTWARE

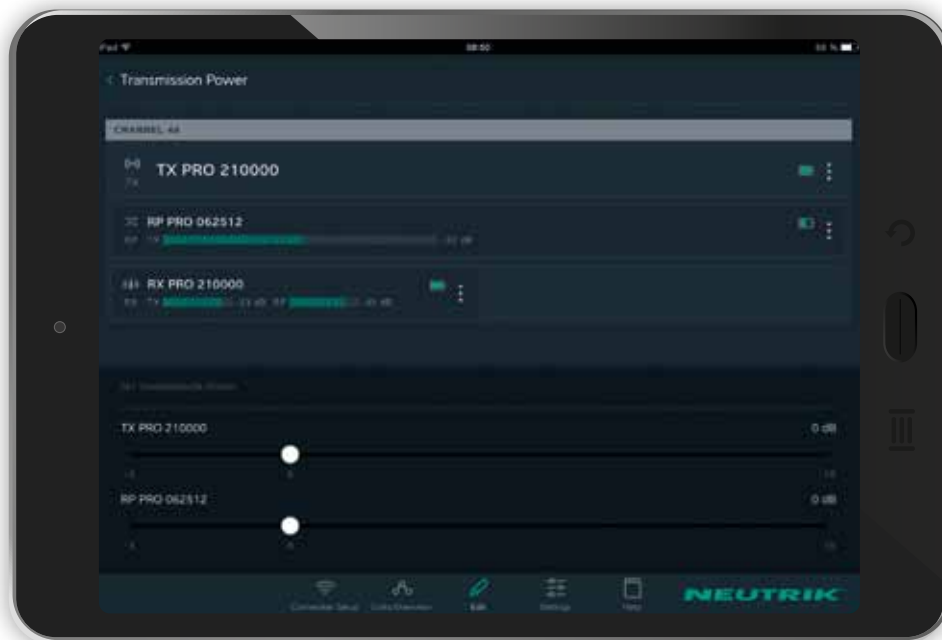

The XIRIUM PRO app facilitates the setting of all function parameters and the monitoring of the wireless devices with iOS or Android devices.

The software makes optimising the aerial alignment respectively determining the location of the repeater a breeze and also serves as a useful tool during set up. The XIRIUM PRO app facilitates the setting of all function parameters (e.g. delay time, etc.) and the monitoring (e.g. signal strength, battery power, etc.). Future functional expansion or performance optimisation of the wireless devices can easily be accomplished via the firmware update function.



PLUG AND PLAY



XIRIUM PRO is the ideal tool for establishing audio connections quickly and offers the ultimate in system design flexibility.

Instantly ready for service – just like with a cable

Simply push a button for connecting the devices with each other, which are instantly ready for operation. The memory function simplifies the set up for future projects.

Effortless installation

Thanks to the license-free, automatic frequency management, XIRIUM PRO channels do not require a license, as is the case with other wireless systems.

Set up optimising

The XIRIUM PRO app (for iOS and Android) enables you to setup, configure, and monitor all aspects of system functions.



The modular concept, flexible power supply and robust design opens up a wide field of applications.

Robust mechanical design

With its ruggedized outdoor rated housing (IP54), the system can be used indoors or outdoors and offers the ultimate flexibility.

Flexible power supply

XIRIUM PRO units can be operated either on 100-240 VAC 50/60 Hz mains power or on the internal Li-Ion Battery Pack (typical battery runtime 10 hours, depending on type of module, transmission power settings, XROC mode, number of charging cycles and temperature).

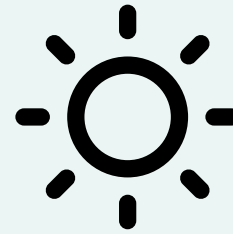

outdoor



IP54



internal battery



100-240 VAC
50/60 Hz



PLUG AND PLAY



XIRIUM PRO is the ideal tool for establishing audio connections quickly and offers the ultimate in system design flexibility.

Input and output module options handle common signal type

Whether the signal type is analog, digital (AES/EBU) or Dante, XIRIUM PRO offers modules to accept any of them. Signal types may also be converted from one type to another, simply by selecting the appropriate module. Need to transmit an analog signal and plug into a digital input? No problem. Select an analog input module for the transmitter, and the AES digital output module for the receiver. In fact, every receiver in a system can use a different output module, allowing for signal conversion to the type used by your device.

INPUT	OUTPUT		
	ANALOG LINE	DIGITAL AES/EBU	DANTE
ANALOG LINE	✓	✓	✓
DIGITAL AES/EBU	✓	✓	✓
DANTE	✓	✓	✓



Input and output module options handle common signal type.



SIMPLE IMPLEMENTATION

... into the world of professional digital wireless audio transmission.

Transmitter TX and receiver RX are connected to each other within seconds – facilitating quick adoption into the world of DiWA technology and providing the ease of wireless audio transmission with high-level sound quality. The audio signal transmitted by the TX can be received by an unlimited number of RX receivers. Thus XIRIUM PRO becomes the preferred solution with simple implementation in numerous applications.



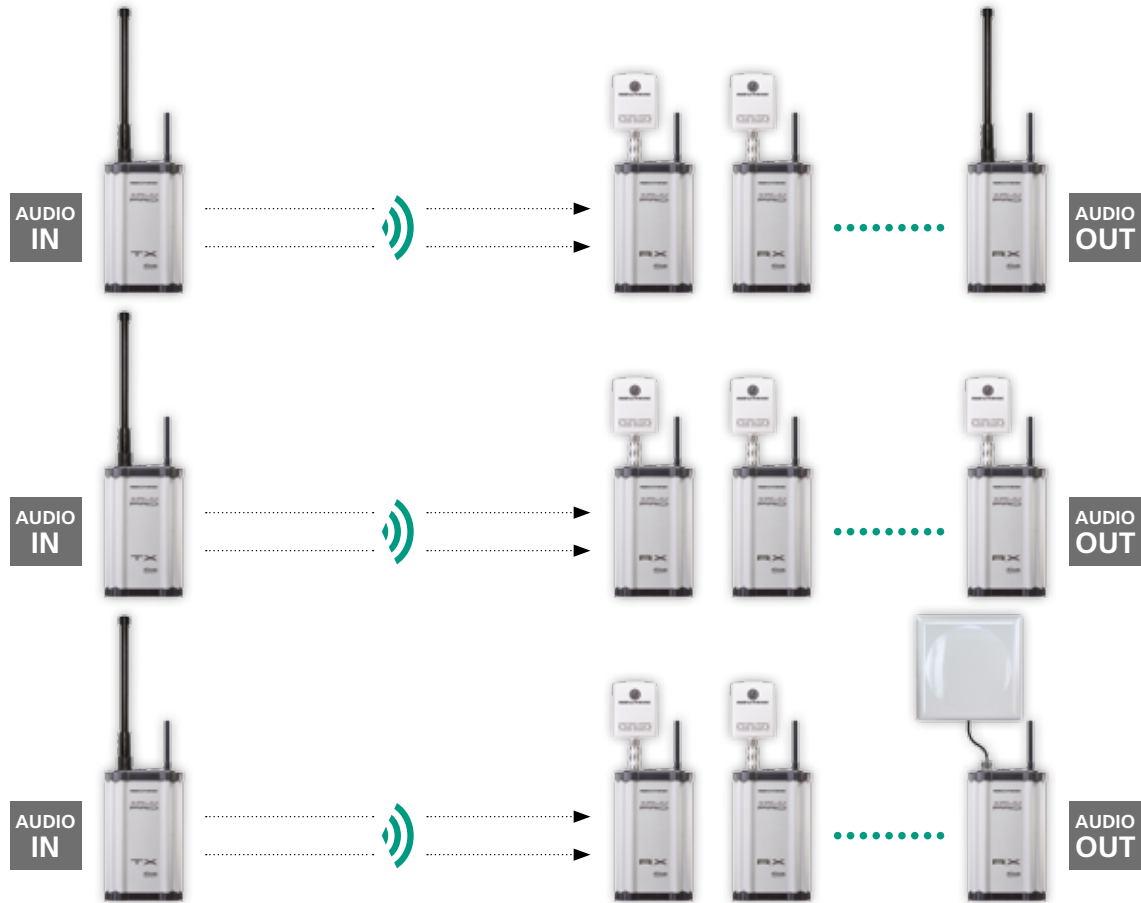

... of the system to a digital wireless audio solution with up to 6 audio channels.

The system may be expanded to six sound channels for the transmission of several, discrete audio signals. For this purpose three TX transmitters may be operated in parallel. This set up allows the use of an unlimited number of RX receivers.

XIRIUM PRO app
iOS and Android



THE EXPANSION

BREAKING WIRELESS BARRIERS

... extending the range with a repeater.

The RX can either be used as a receiver or, by changing the output module to a repeater module, as a repeater. In repeater mode the RX forwards the audio signal received from the TX without any changes, which in turn can now be received by an unlimited number of RX receivers set to reception mode. The repeater represents the perfect addition to the system: it doubles the range of the system and helps to overcome walls, corners or other obstacles.

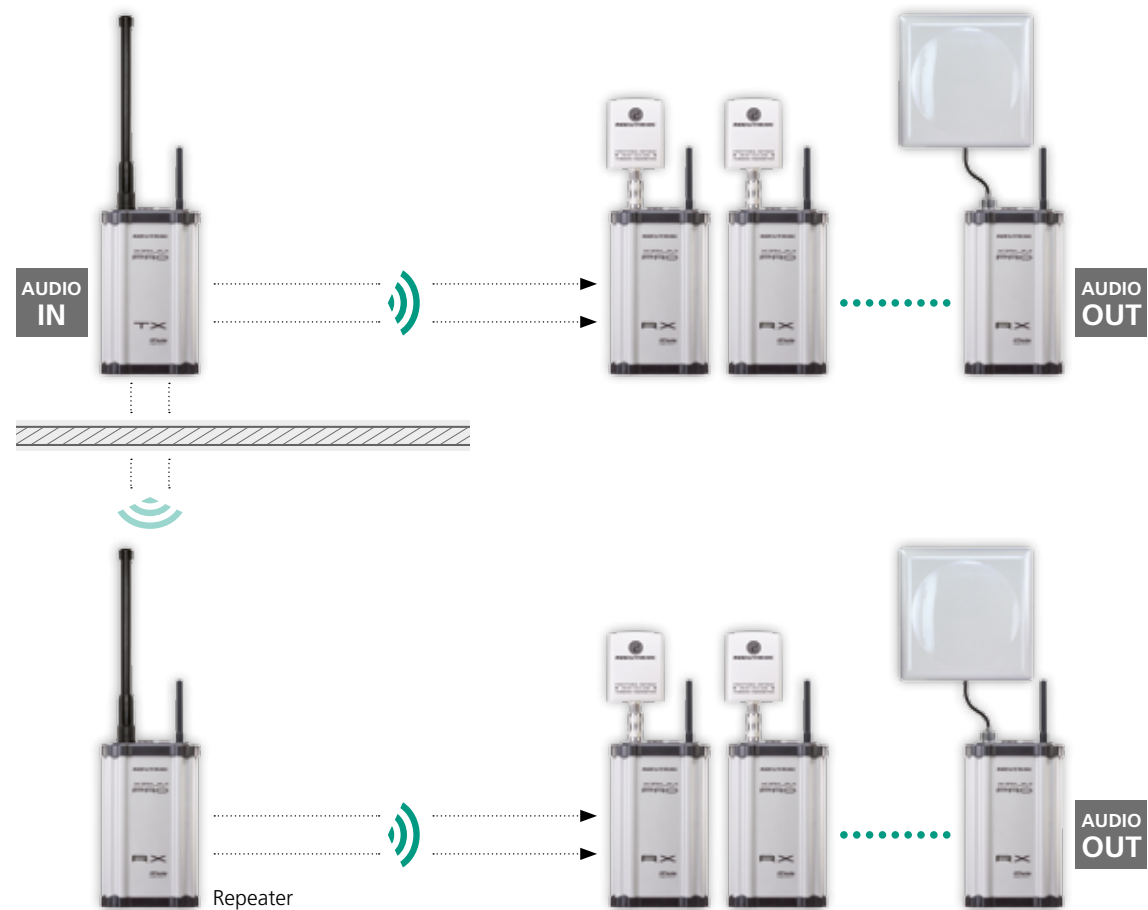

XIRIUM PRO app
iOS and Android



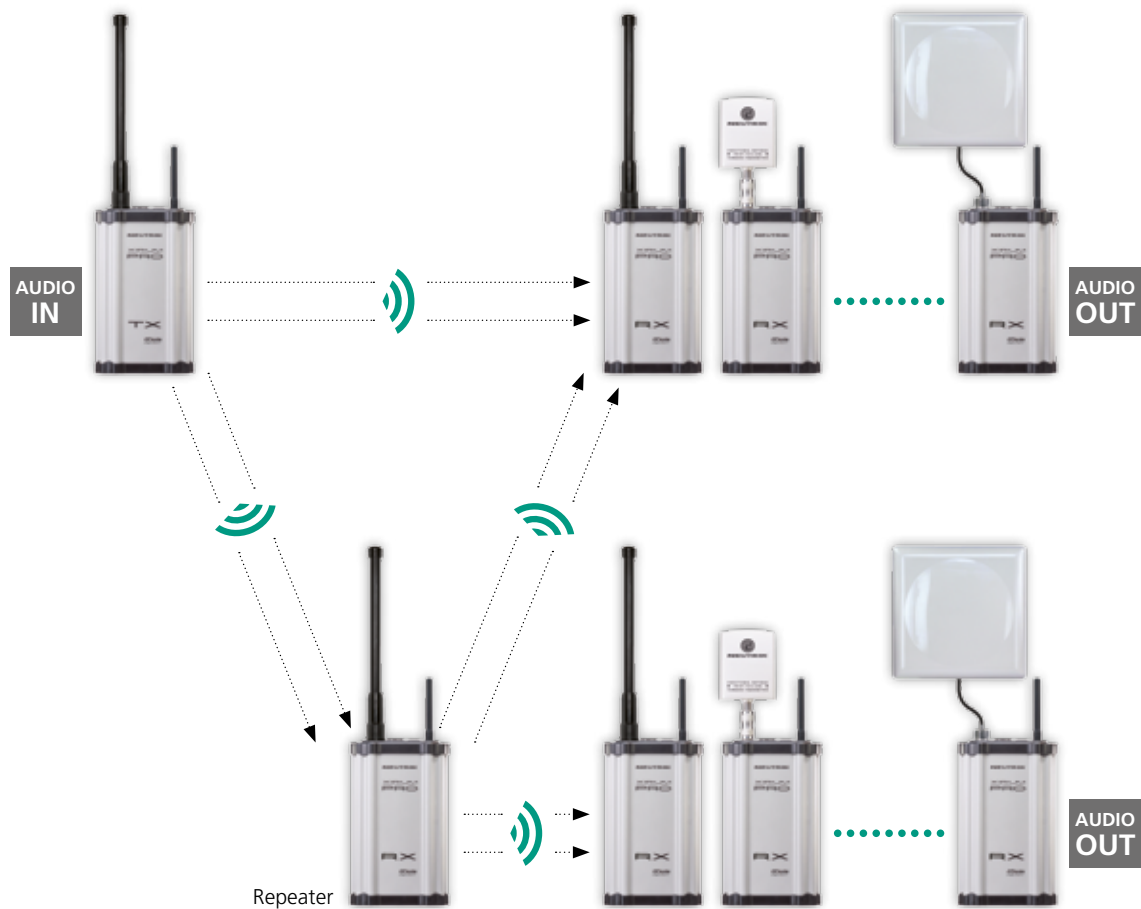

... using the repeater as a redundant audio source (extended true diversity).

Beside enhancing the range or overcoming obstacles, the RX-repeater offers another feature: since the repeater duplicates and transmits the signals received from the TX, it becomes a second redundant audio source for every other RX. In other words, an RX located within the reception area of an TX and a repeater, can now choose one of two identical signals and automatically selects the one with the better signal quality.

XIRIUM PRO app
iOS and Android



GREATER RELIABILITY

QUICK SETUP AND RELIABLE OPERATION

From zero to live in no time at all.

Highest reliability coupled with quick setup and tear-down – this is the fundamental concept of XIRIUM PRO. Conventional signal sources as well as active loudspeakers can be integrated in the system without complex wiring.

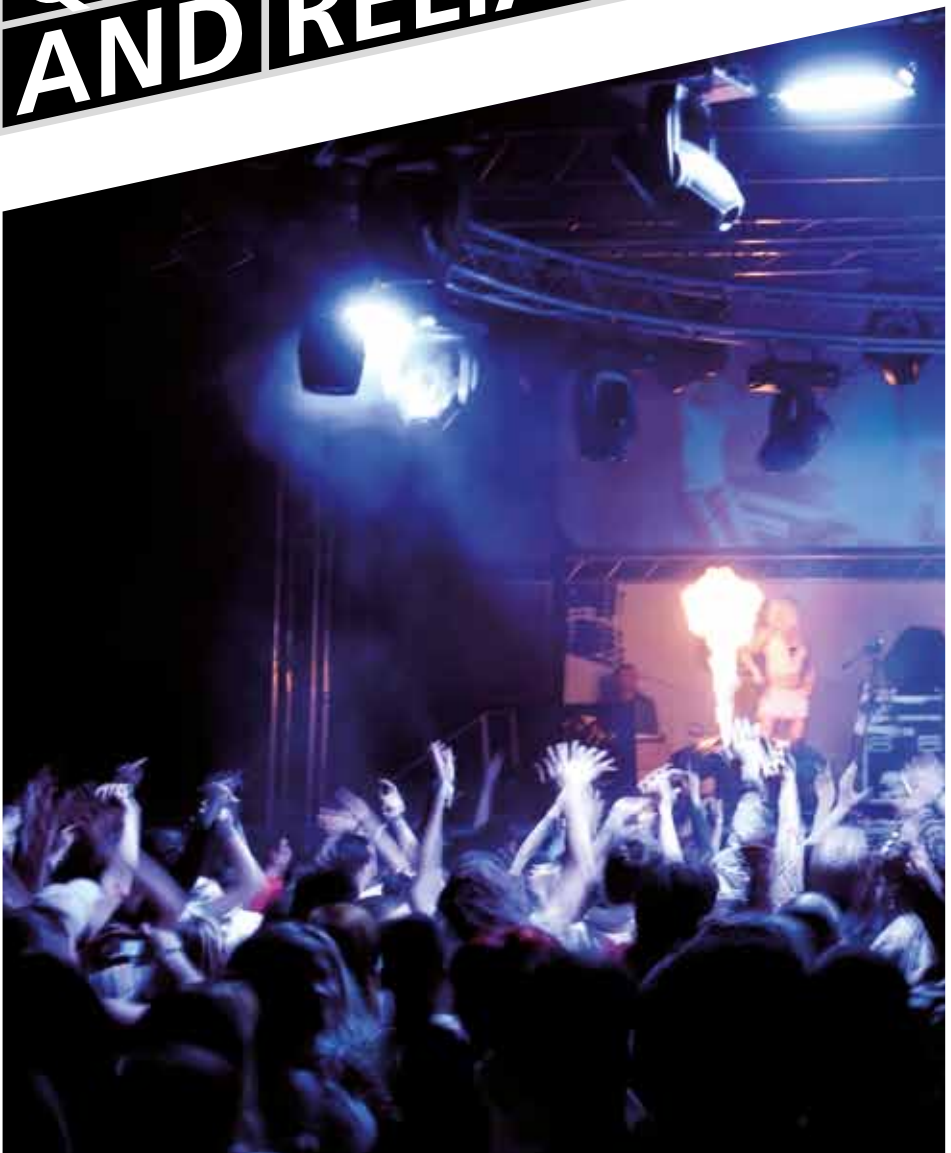



Mount it – power it – use it.

Whether it is a sporting event, election event, or a presentation, the XIRIUM PRO solution allows the successful operation of many applications without time-consuming technical planning and setup work. The flexibility of the system is unique and enables swift and efficient implementation without complex wiring.



**EASY TO USE AND FLEXIBLE
IN ANY APPLICATION**

WHEN RUNNING A CABLE JUST WON'T DO

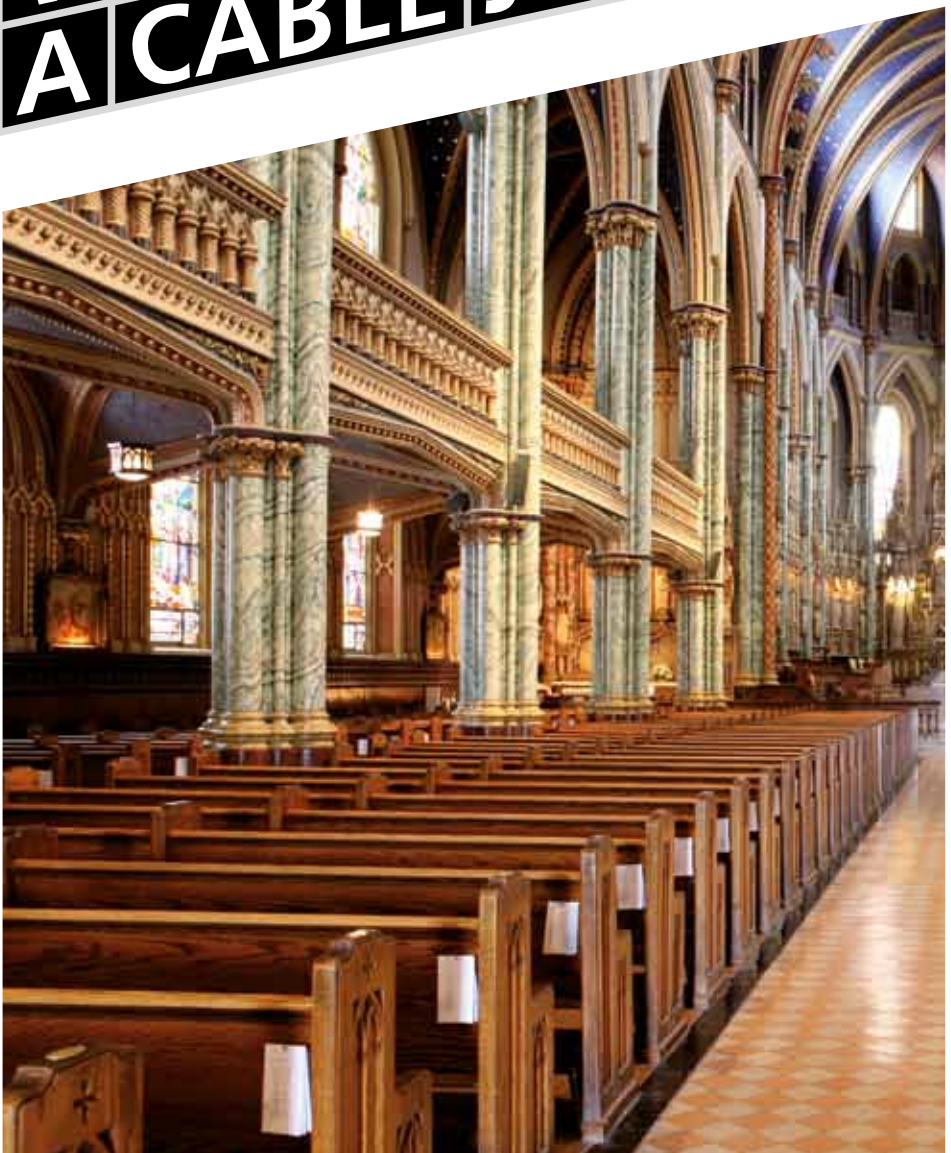

Let the venue stand out, not the cable running through it.

In churches or historical buildings wiring of an audio system is often not possible without considerable time-consuming technical efforts. In these situations XIRIUM PRO excels not only with its concept, but in its ability to allow wireless integration of an entire worship service. Thus, making it easy to handle and efficient.



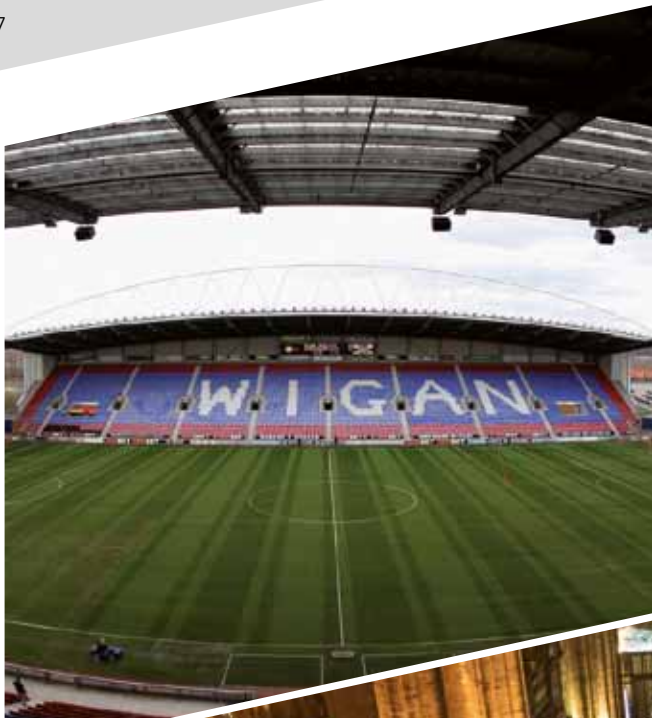

APPLICATIONS

REFERENCES



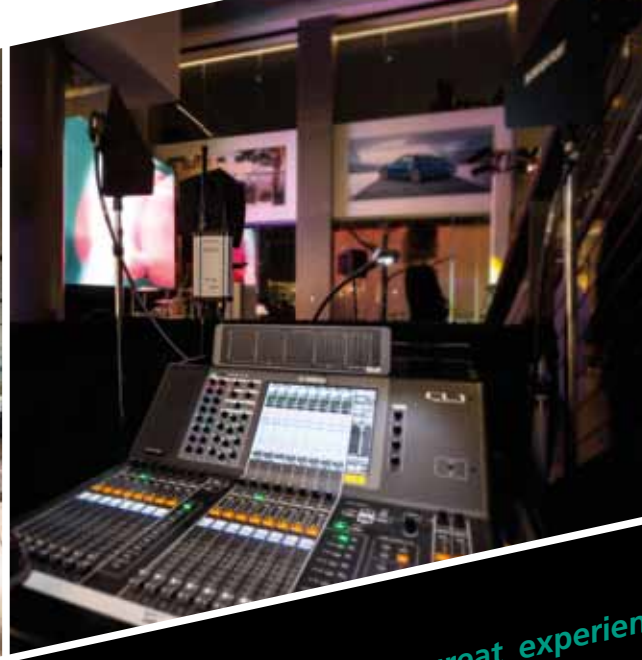

»Using Xirium was a great experience. The system worked flawlessly and provided exactly what we needed for a high profile environment, with a low impact installation in one of the most densely populated RF environments to contend with. The capabilities of Xirium allowed us to reduce our required installation time plus meet the request from our clients to not pollute their brand new facility with lots of temporary wiring routed throughout. We were able to keep a great visual appearance, with minimal impact on the venue all while maintaining perfect audio distribution to our speakers.«

Mark Boettcher / Senior Audio Engineer / PRG



REFERENCES



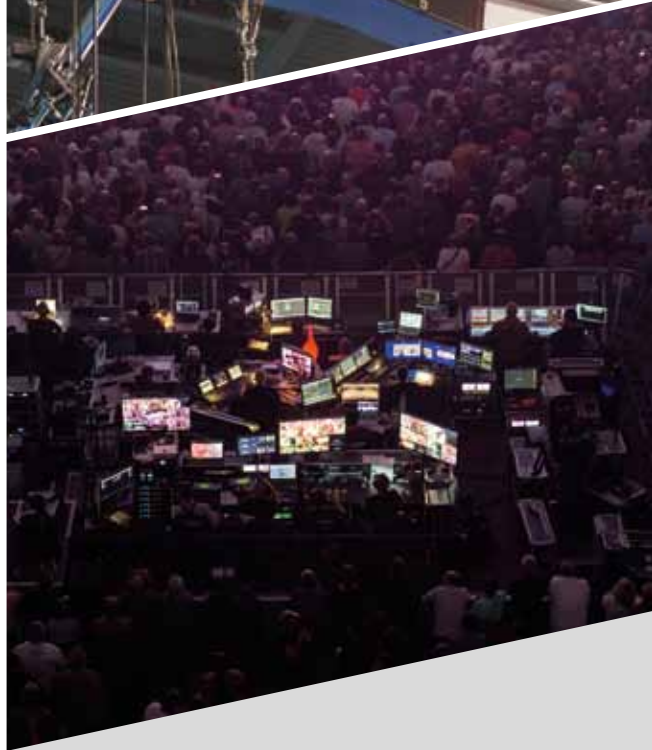
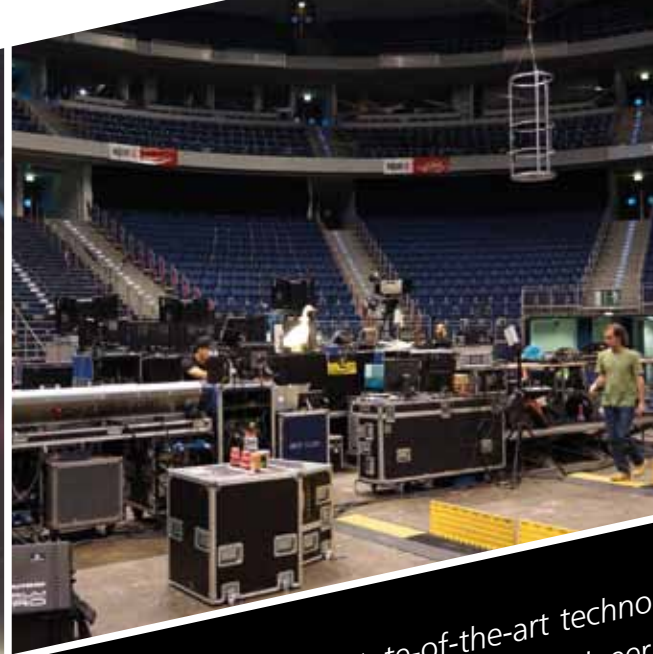

To keep on top of state-of-the-art technology, satis&fy – the international event specialist – and the freelance sound engineer Arnd Wagner tested the new wireless solution XIRIUM PRO from Neutrik. Sound engineer Arnd Wagner summed up his test of Neutrik's XIRIUM PRO after two concerts in Hannover/Germany:

»The transmission with XIRIUM PRO worked perfectly – two shows without any failure! And the sound was really comparable to cable transmission. The app made a very good impression. I think it's indispensable to be able to see, in the app, if the receivers simply receive a signal or if they are all truly in the green (good) area.«

Arnd Wagner | Sound engineer

SYSTEM COMPONENTS



NXP-TM-ANA-E



NXP-TM-AES-E



NXP-TM-DANTE-E



NXP2TX-E



NXPA-2-360



NXPA-6-360-25

XIRIUM PRO SYSTEM COMPONENTS

TYPE NO.	DESCRIPTION
NXP2TX-E	TX Base unit / including NXPA-6-360-25, NXPA-WIFI, NKXPRO-DATA, NXUC-M-15
NXP-TM-ANA-E	TX Analog line input module / without Power Cable NKXPF
NXP-TM-AES-E	TX Digital AES/EBU input module / without Power Cable NKXPF
NXP-TM-DANTE-E	TX Digital DANTE input module / without Power Cable NKXPF

ACCESSORIES

NXPA-2-360	5 GHz antenna 2dBi 360°H 360°V
-------------------	--------------------------------



XIRIUM PRO SYSTEM COMPONENTS

TYPE NO.	DESCRIPTION
NXP2RX-E	RX Base unit / including NXPA-WIFI, NKXPRO-DATA, NXUC-M-15 / without 5 GHz antenna!
NXP-RM-ANA-E	RX Analog line output module / without Power Cable NKXPF
NXP-RM-AES-E	RX Digital AES/EBU output module / without Power Cable NKXPF
NXP-RM-DANTE-E	RX Digital DANTE output module / without Power Cable NKXPF
NXP-RM-RP-E	RX Repeater module / without Power Cable NKXPF

ACCESSORIES

NXPA-2-360	5 GHz antenna 2dBi 360°H 360°V
NXPA-6-360-25	5 GHz antenna 6dBi 360°H 25°V
NXPA-14-40-35	5 GHz antenna 14dBi 40°H 35°V
NXPA-18-18-18	5 GHz antenna 18dBi 18°H 18°V

SYSTEM COMPONENTS

NKXPRO-DATA



NKXPA-5



type F

type G

type J



NXUC-M-15



NXPMA



NXPA-WIFI



NKXPF-...

NXPA-6-360-25



NXPA-18-18-18



NXPA-N-FF



NXPA-2-360



NXPA-14-40-35



CAS-NXP



CAS-NXP-T



XIRIUM PRO SYSTEM COMPONENTS

ACCESSORIES

NXPA-2-360	5 GHz antenna 2dBi 360°H 360°V
NXPA-6-360-25	5 GHz antenna 6dBi 360°H 25°V
NXPA-14-40-35	5 GHz antenna 14dBi 40°H 35°V
NXPA-18-18-18	5 GHz antenna 18dBi 18°H 18°V
NXPA-WIFI	2,4 GHz omni-directional antenna for app connection
NKXPRO-DATA	Data cable XIRIUM PRO
NKXPA-5	Antenna cable XIRIUM PRO
NKXPF-...	Power cable 3 m / NKXPF-F-3 (Schuko/Europe), NKXPF-G-3 (BS 1363/UK), NKXPF-J-3 (SEV 1011/Swiss)
NXUC-M-15	Manfrotto™ universal mounting clamp
NXPMA	Mounting arm for antennas (NXPA-14-14-35, NXPA-18-18-18, NXPA-6-360-25), compatible with Manfrotto™ clamp
NXPA-N-FF	N Adapter female for remote TX antenna (cable not included)
CAS-NXP	Flightcase with foam cut-outs (not equipped)
CAS-NXP-T	Hard case (trolley) with foam cut-outs to hold 3 devces (not included)

TECHNICAL INFORMATION

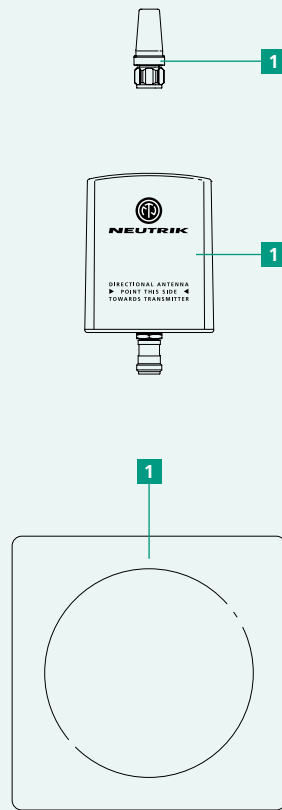
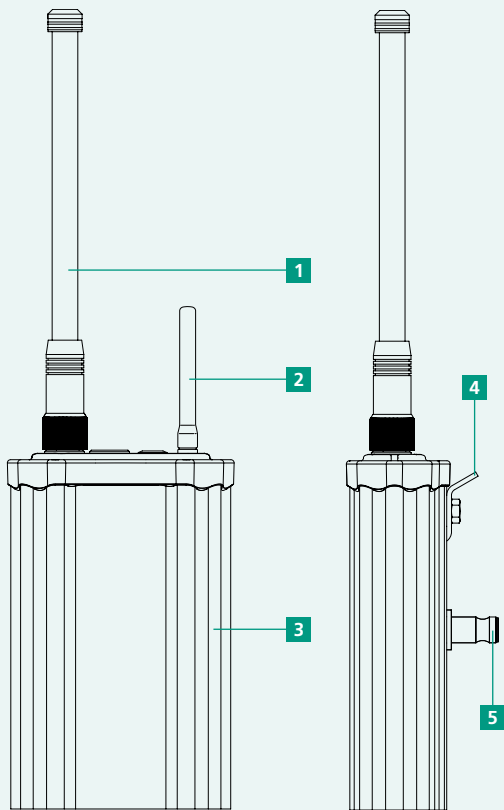

XIRIUM PRO BASE UNIT WITHOUT MODULE

OPERATING ELEMENT	FUNCTION
1 5 GHz antenna connector	Antenna / N-type connector for 5 GHz antenna
2 2,4 GHz antenna connector	Antenna / Reverse SMA connector for 2.4 GHz antenna
3 Housing	Extruded aluminium sheath housing
4 Lug	Safety-lug for rigging hardware
5 Mounting Stud	Adapter for use with a Manfrotto™ clamp
6 On/Off switch	Powering On/Off the device; LED indication
7 Link button	Link devices; switch XROC On/Off mode; reset transmission power
8 Link button	Link devices; switch Delay On/Off
9 D Sub connector	Interface between base station and module
10 USB port	USB connection for firmware updates

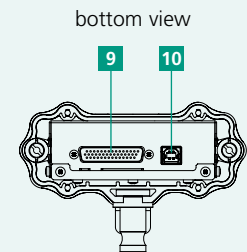
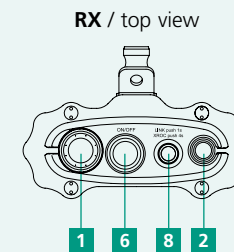
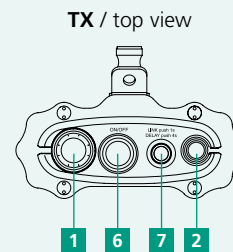

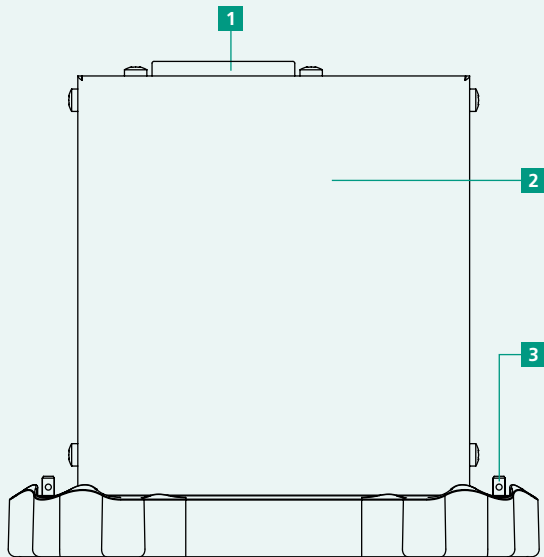

MODULE / top view

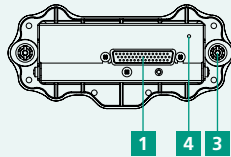

MODULE / bottom view

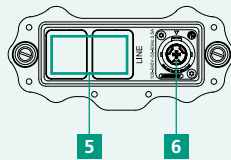

XIRIUM PRO MODULES

OPERATING ELEMENT	FUNCTION
1 D-SUB connector	Interface between base station and module
2 I/O Module	Module with integrated battery
3 Locking bolt	Locking module to base station
4 Status LED	LED charging indicator
5 Input/Output	Audio IN (TX), Audio OUT (RX)
6 Power connector	powerCON TRUE1 chassis

XIRIUM PRO – SPECIFICATIONS

GENERAL SPECIFICATIONS

Radio frequency carrier range	IEEE 802.11a, UNII-3 band from 5725 MHz to 5825 MHz (channels 149-165), license-free
Data protocol	Proprietary (DiWA technology)
Transmit power	conducted 8 dBm / 14 dBm (with 6 dBi antenna)
Range	Up to 500 m point to point (LOS), longer range depending on obstacles, reflexions, interferences, XROC mode

AUDIO PERFORMANCE (ANALOG TO ANALOG PER WIRELESS LINK)

THD + Noise (TX Gain = min.)	< 0.01 % @ 1 kHz, 4 dBu / < 0.05 % @ 20 Hz – 10 kHz, 4 dBu
Frequency response	+0.5 dB / -1.5 dB @ 20 Hz – 20 kHz ref. 1 kHz
Dynamic range	> 105 dB @ 1 kHz, A-weighted
Crosstalk	< -80 dB @ 20 kHz
Number of audio channels @ 24 mbps	2
Number of audio channels @ 6 mbps	1 (XROC mode)
Number of receivers (RX only)	Unlimited number of RX clients
Converter resolution (ADC & DAC)	24 bit
Sampling rate	48 kHz
Latency (Delay)	3.6 msec (analog to analog)
Transmission method	Compression-free, no reduction of converted data
Operating temperature	32° F to +122° F / 0 °C to +50 °C
Storage temperature	-4° F to +176° F / -20 °C to +80 °C

ADDITIONAL DIGITAL AUDIO INTERFACES

AES/EBU	24 bit / 48 kHz according to AES3-2003
Dante AoE (Audio over Ethernet)	proprietary protocol by Audinate®

XIRIUM PRO – SPECIFICATIONS

TX SPECIFIC CHARACTERISTICS

Antenna 5-6 GHz – Audio Transmission	Omni-directional, N-connector male (direct mount)
Antenna 2.4 GHz – Monitor & Control	1/2 wave dipole with SMA female connectors
Number of audio channels @ 24mbps	2
Number of audio channels @ 6mbps	1 (XROC mode)

ANALOG INPUT SPECS:

Input Mode	Input Level			
	Input Imp. kOhm	Rated Source Imp. Ohm	Max. * dBu	Connector type
Line (balanced)	10	1000	22	XLR
Indicators	LEDs: Power ON / Start Up / Low Battery Status / XROC mode / Linking Process / Audio transmission			
Controls	Power ON / Linking Process / XROC mode			
Power Supply	Mains input over powerCON TRUE1 (100-240 VAC 50/60 Hz) or internal battery **			
Dimensions (w x h x d)	5.6 x 2.5 x 9.7 in / 142 x 64 x 247 mm (without antennas)			
Weight	1.59 lbs / 0.72 kg			
Optional Accessories	Module Interfaces (Analog, Digital, Dante), mounting clamp			

* maximum input level before signal overflow, 0 dBu = 0.775 V rms

** typical battery runtime 10 hours, depending on type of module, XROC mode, number of charging cycles and operating temperature

XIRIUM PRO – SPECIFICATIONS

RX SPECIFIC CHARACTERISTICS

Antenna 5-6GHz - Audio Transmission	Omni-directional / directional, N-connector male
Antenna 2.4GHz - Control Data Transm.	1/2 wave dipole with SMA female connectors
Number of audio channels	2

ANALOG OUTPUT SPECS:

Output Type	Output Level				
	Output Imp. Ohm	Rated Load Imp. kOhm	Nominal * dBu	Max. Level dBu	Connector type
Line Output (balanced)	< 800	10	0	22	XLR
Indicators	LEDs: Power ON / Start Up / Low Battery Status / Audio Delay / Linking Process / Audio Reception				
Controls	Power ON / Linking Process / Audio Delay				
Power Supply	Mains input over powerCON TRUE1 (100-240 VAC 50/60 Hz) or internal battery **				
Dimensions (w x h x d)	5.6 x 2.5 x 9.7 in / 142 x 64 x 247 mm (without antennas)				
Weight	1.59 lbs / 0.72 kg				
Optional Accessories	Module Interfaces (Analog, Digital, Dante), mounting clamp				

* if TX source = 0dBu

** typical battery runtime 10 hours, depending on type of module, XROC mode, number of charging cycles and operating temperature

XIRIUM PRO – SPECIFICATIONS

ANTENNAS – Frequency band: 5.150 GHz - 5.875 GHz

Type	NXPA-2-360	NXPA-6-360-25	NXPA-14-40-35	NXPA-18-18-18
Gain	2 dBi	6 dBi	14 dBi	18 dBi
Beam width horizontal	360°	360°	40°	18°
Beam width vertical	360°	25°	35°	18°
Connector	N-connector male	N-connector male	N-jack female	N-jack female
Dimensions	2.17 in x 0.87 in 55 mm x 22 mm	10.63 in 270 mm	7.48 in x 7.48 in x 1.18 in 190 mm x 190 mm x 30 mm	4.02 in x 3.19 in x 1.42 in 102 mm x 81 mm x 36 mm
Weight	0.11 lbs / 0.05 kg	0.75 lbs / 0.34 kg	0.24 lbs / 0.11 kg	1.5 lbs / 0.7 kg
Operating temperature	-40°F to +185°F -40°C to +85°C	-40°F to +185°F -40°C to +85°C	-40°F to +185°F -40°C to +85°C	-40°F to +158°F -40°C to +70°C
IP rating	IP69K	IPx5	IP66 / IP67 (IEC 60529)	IP67



OUT

DANTE





LIECHTENSTEIN (HEADQUARTERS)

NEUTRIK AG, Im alten Riet 143,
9494 Schaan, Liechtenstein
T +423 237 24 24, F +423 232 53 93, neutrik@neutrik.com

USA

Neutrik USA Inc., 4115 Taggart Creek Road,
Charlotte, North Carolina, 28208
T +1 704 972 30 50, info@neutrikusa.com

GERMANY / NETHERLANDS / DENMARK / AUSTRIA

Neutrik Vertriebs GmbH, Felix-Wankel-Strasse 1,
85221 Dachau, Germany
T +49 8131 28 08 90, info@neutrik.de

FRANCE

Neutrik France SARL, Rue du Parchamp 13,
92100 Boulogne-Billancourt
T +33 1 41 31 67 50, info@neutrik.fr

GREAT BRITAIN

Neutrik (UK) Ltd., Westridge Business Park, Cothey Way
Ryde, Isle of Wight PO33 1 QT
T +44 1983 811 441, sales@neutrik.co.uk

CHINA

Ningbo Neutrik Trading Co., Ltd., Shiqi Street, Yinxian Road West
Fengjia Villiage, Haishu District, Ningbo, Zhejiang; 315153
T +86 574 88250488 800, neutrik@neutrik.com.cn

HONG KONG

Neutrik Hong Kong LTD., Suite 18, 7th Floor Shatin Galleria
Fotan, Shatin
T +852 2687 6055, neutrik@neutrik.com.hk

JAPAN

Neutrik Limited, Yusen-Higashinohonbashi-Ekimaie Bldg., 3-7-19
Higashinohonbashi, Chuo-ku, Tokyo 103
T +81 3 3663 47 33, mail@neutrik.co.jp

INDIA

Neutrik India Pvt. Ltd., Level 3, Neo Vikram, New Link Road,
Above Audi Show Room, Andheri West, Mumbai, 400053
T +91 982 05 43 424, anklesaria@neutrik.com

ASSOCIATED COMPANIES

Contrik AG, Steinackerstrasse 35, 8902 Urdorf, Switzerland
T +41 44 736 50 10, contrik@contrik.ch
H. Adam GmbH, Felix-Wankel-Straße 1, 85221 Dachau, Germany
T +49 08131 28 08-0, info@adam-gmbh.de

www.neutrik.com / www.xirium.net

XIRIUM PRO Product Guide 2017 – NF17-EU-E-V3 – Data subject to change without prior notice. © 2017 NEUTRIK®.
NEUTRIK®, XIRIUM®, DIWA® are registered trademarks of NEUTRIK AG. Dante™ is a registered trademark of Audinate. ALL RIGHTS RESERVED.