

**TRUST
THE
ORIGINAL**

Plugs & Jacks



NEUTRIK®

Content	Page
Plugs:	
1/4" Phone Plug - PX & RPX Series	4
1/4" Phone Plug - crystalCON.....	5
1/4" Phone Plug - jumboPLUG.....	5
1/4" Phone Plug - silentPLUG	6
1/4" Phone Plug - timbrePLUG	7
1/4" Phone Plug - ultimatePLUG.....	8
1/4" Phone Plugs - C Series.....	9
MIL / B-Gauge Type Phone Plugs.....	9
0.173" Bantam Type Miniature Plugs.....	10
3.5 mm Right-Angle Stereo Plug.....	10
Technical Data	11
Ordering Information	12
Accessories	13
Jacks:	
Locking 1/4" Cable Jacks	15
Locking 1/4" Chassis Jacks	16
1/4" Vertical Jacks	17
1/4" Jacks - M Jacks	18
1/4" Jacks - Slim Jacks	19
1/4" Jacks - Stacking Jacks	20
Technical Data	21
Ordering Information	22
Accessories	24
Inline Adapter:	
1/4" Inline Adapter - plug2PLUG	25
Ordering Information	25
Phono (RCA):	
Profi - RCA Serie	26
Phono Socket.....	27
Technical Data.....	28
Ordering Information	28
Accessories	28
General information:	
Definition, Abbreviation & Useful Information	29
Neutrik Part Number Guide	30
Neutrik Product Line	31

Plugs & Jacks



Introduction



The Neutrik® plug and jack program offers a wide range of professional phone connectors including 1/4", 3.5 mm, MIL/B-gauge style and TT or bantam style plugs. The jack range offers an exceptional "slim" 1/4" PCB jack that is almost 20 % smaller than most other designs. The heavy duty M line combines a wide range of options such as three different nose forms and four styles of contacts including 3 PCB and one solder tab. It also includes a 1/4" chassis and cable jack line with the secure locking feature, well known from the XLR range. All jacks are manufactured from strong high-grade thermoplastics and are available in all common versions which make them suitable for audio and industrial applications.

The plug line features:

- Mono (TS) and Stereo (TRS) plugs
- Straight and right-angle versions
- Rugged diecast shell in nickel or black chromium
- Nickel or gold plated contacts
- Chuck type strain relief
- Precision machined plugfinger without rivets
- Coloured boots and rings for coding
- Silent Plug , timbrePLUG and ultimatePLUG for instrument (guitar) applications

All plugs and jacks are specified to IEC 60603-11 and EIA RS-453 or the respective MIL standard.

Neutrik® also offers a special jack version which is a combined 3 pole XLR receptacle and a 1/4" phone jack for balanced mic or line inputs in one XLR shell. This "one for two" panel mount offers substantial cost, labour and material savings. For more information on the Combo products see section XLR connectors page 24 and 25 or visit our website at www.neutrik.com.

Plugs

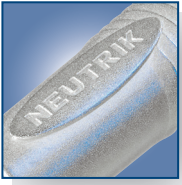

Neutrik brand

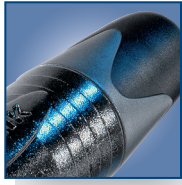

Anti-kink bushing



Chuck type strain relief



White painted housing

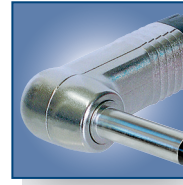

Right angle plug

1/4" Phone Plug – PX and PRX Series



NP2X



NP3X-B



NP2X-WT



NP3RX-B

- Slim 1/4" plug with million fold proven chuck type strain relief
- Precision machined one piece contacts – no rivets
- Sleek attractive design for best handling convenience
- 14.5 mm only in diameter (right angle 15.4 mm) – serves highest packing density of 15.88 mm jack pitch
- Nickel or gold plugfinger in mono (TS) and stereo (TRS)
- Screwless assembly (PRX series as well)
- L-D version available which accommodates cable O.D.s up to 8 mm

NP2X

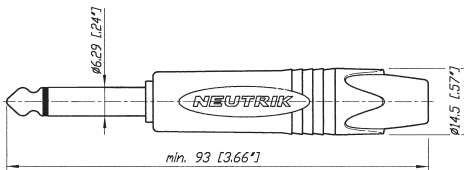

NP2RX

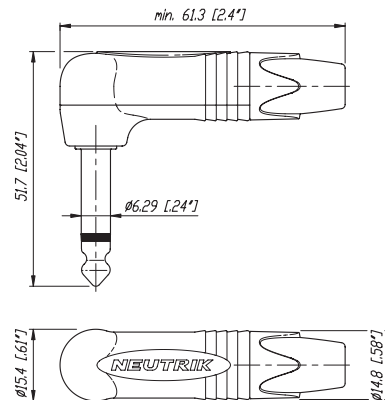

15.88 mm jack pitch:





CRYSTALLIZED™ – Swarovski Elements

crystalCON



Robust metal housing



Big bushing for cable up to 10 mm

jumboPLUG

1/4" Phone Plug – crystalCON



NP2X-B-CRYSTAL

- Mono 1/4" phone plug embellished with CRYSTALLIZED™ – Swarovski Elements
- Fancy, noble, valuable, attractive package – an eye-catcher

1/4" Phone Plug – jumboPLUG



NP2XL

- 2 or 3 pole 1/4" professional phone plug
- Up to 10 mm cable O.D.
- Robust diecast shell in stylish design
- Proven chuck type strain relief for reliable cable retention
- Ergonomic design for best handling convenience
- Precision machined one piece contacts – avoid hook up of tip contact

NP2X-B-CRYSTAL

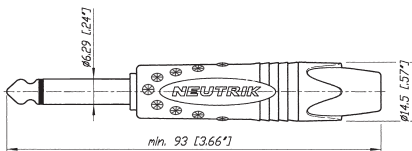

NP3XL

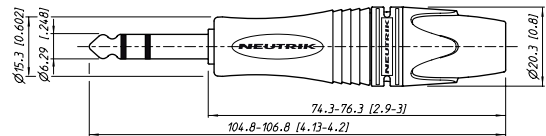



Moving magnet



Right angle plug

silentPLUG

1/4" Phone Plug – silentPLUG



NP2X-AU-SILENT



NP2RX-AU-SILENT

- Avoids pops and squeals
- Hermetically sealed switching contacts
- Lifetime beyond 1'000 mating cycles
- Slim right-angle plug with industry proven and reliable chuck type cable strain relief
- Sleek attractive design for convenient handling and connections
- Rubber overlay on straight housing for best shock-protection and reliability
- L-D version available accommodating up to 8 mm

Attention!

For use with instrument (guitar) applications only. Damage may occur if connected to amplifier output. (Battery) powered devices such as preamps and effects might not work in combination with the silentPLUG.

NP2X-AU-SILENT

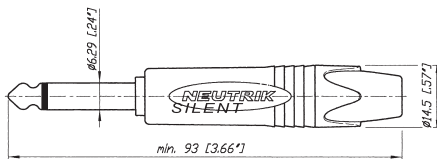

Design Criteria

The silentPLUG automatically mutes (shorts) an instrument (guitar) cable to avoid pops and squeals when changing the instrument (guitar) under load.

The integrated silent switch (pat. pending) is based on REED-technology and guarantees a lifetime beyond 1'000 mating cycles. The PX silentPLUG features a rugged metal shell enhanced with a rubber cushion overlay for improved shock protection.

Detail Silent Switch:

Hermetically sealed

Gold plated contacts

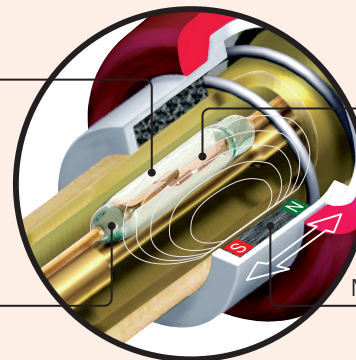

REED SWITCH

Moving magnet

- Cannot corrode or pollute
- No wear, constant contact resistance
- Decoupled from switching mechanism



Rotary knob to change the timbre



Right angle plug

timbrePLUG

1/4" Guitar Plug – timbrePLUG



NP2RX-TIMBRE



- Standard timbre of your cable plus 3 additional sound characteristics
- Slim right-angle plug with industry proven and reliable chuck type cable strain relief
- Sleek attractive design for convenient handling
- Gold plug finger, precision machined one piece contacts

Design Criteria

The characteristic sound of a guitar is not only influenced by the guitar (strings, pickups, body) alone but also by the attached instrument cable and the following guitar amp. The timbrePLUG provides the possibility to change the timbre of your guitar sound from neutral, clear sound to warm characteristics.

timbrePLUG - characteristic

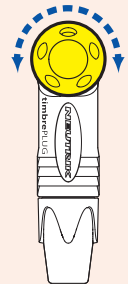
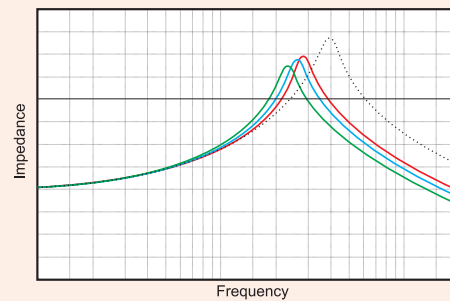

- neutral position / basic sound characteristic
- position 1 / sound characteristic 1
- position 2 / sound characteristic 2
- position 3 / sound characteristic 3

NP2RX-TIMBRE

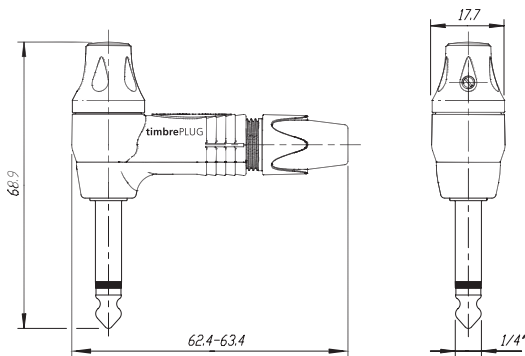



Rotary knob to change the timbre



Right angle plug



Moving magnet

Attention!

For use with instrument (guitar) applications only. Damage may occur if connected to amplifier output.

ultimatePLUG

1/4" Guitar Plug – ultimatePLUG



NP2RX-ULTIMATE

- 2 in 1 – combines timbrePLUG & silentPLUG
- Change of timbre and avoiding of pop and squeals are combined in one plug
- The ultimate guitar plug
- Slim right-angle plug with industry proven and reliable chuck type cable strain relief
- Sleek attractive design for convenient handling
- Gold plug finger, precision machined one piece contacts

Details of **silentPLUG** on page 6 and **timbrePLUG** characteristics on page 7.

NP2RX-ULTIMATE

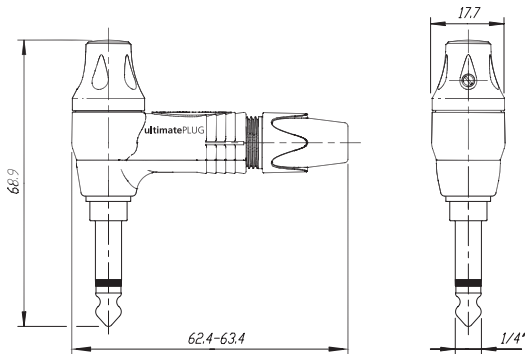



The standard of professional phone plugs



B-Gauge type

1/4" Phone Plug – C Series



NP2C + BSP-3

- Available in mono (TS) or stereo (TRS)
- Meets EIA / IEC standards
- Unique plug finger design without rivets
- Sturdy diecast metal shell
- Excellent Neutrik® chuck type strain relief

MIL/B-Gauge Type Plugs



NP3TB-R



NP3CM-B

- 1/4" "B-Gauge" and "MIL" Type Plugs
- All metal design, chuck type strain relief, no rivets
- Meet all prevailing standards
- Available as plug fingers only for overmolding

NP3C

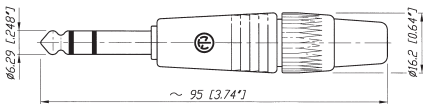

NP3TB-B

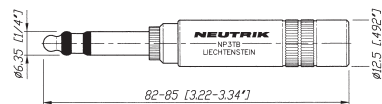

NP3CM-B



Plugs



Bantam plug



Dual bantam plug



Gold plated contacts



Easy connector assembly

0.173" Bantam Type Miniature Plugs



NP3TT-1-B



NP3TT-2

- Very robust ergonomic design
- Gold contact version in combination with the NJ3TTA jack eliminates contact problems due to corrosion or dirt
- The single plug NP3TT-P and the dual bantam plug NP3TT-2 are made for assembling with a standard HEX crimping tool as used with coax cables
- Solder termination for T + R, crimp termination for sleeve contact

NP3TT-1



NP3TT-P

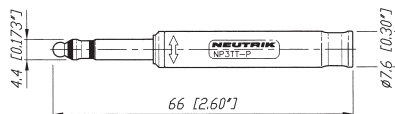

3.5 mm Right-Angle Stereo Plug



NTP3RC



NTP3RC-B

- The only available 3.5 mm plug with chuck type strain relief
- All metal housing – reliable and robust
- Easy to assemble, simple to use
- Slim design – space saving
- Excellent cable protection
- All nickel or black housing, available with gold plated contacts

NTP3RC

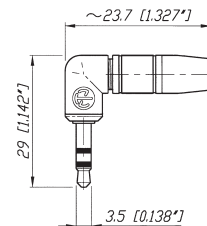

Specifications

1/4" Phone Plugs MIL / B-Gauge Type 0.173" Bantam Type 3.5 mm Stereo Plugs
 SILENT & CRYSTAL
 timbrePLUG & ultimatePLUG
 jumboPLUG

Electrical

Rated current:	depends on mating connector	●	●	●	●
Contact resistance:	depends on mating connector	●	●	●	●
Insulation resistance:	- initial:	> 2 GΩ	●	●	●
	- after damp heat test:	≥ 1 GΩ	●	●	●
	> 0.1 GΩ	ULTIMATE + TIMBRE	●	●	●
Dielectric strength	1 kV dc	●	-	-	-
	200 V dc	SILENT	-	-	-
	100 V dc	ULTIMATE + TIMBRE	-	-	-

Mechanical

Lifetime	> 1'000 mating cycles	●	●	●	●
Wiring:	solder terminals	●	●	●	●
Wire size	mm ²	1	1 (NP3CM: 0.5)	0.25	0.22
	AWG	18	18 (NP3CM: 20)	24	24
Cable O.D.:	mm	4 – 7 (≤ 10: NP*XL)	4 – 7	4 – 4.8	2 – 4.5

Materials

Shell:		Zinc diecast (ZnAl4Cu1) Ni or black Cr plated	Brass (CuZn39Pb3) black or red coated	Brass (CuZn39Pb3) 2 μm Ni (Su) plated PA 6 30 % GR	Zinc diecast (ZnAl4Cu1) Ni or black Cr plated
Insulation:	Polyamide (PA 6.6 30 % GR)	●	●	●	PA 6.6 15% GR
Contacts:	Brass (CuZn39Pb3)	●	●	● (Tip: CuSn6)	●
	2 μm Ni (Su) or Au plated	●	● or Brass	2 μm TRIBOR® (NiP-AuCo)	●
Chuck:	POM	●	●	-	●
Bushing:		POM + PU	-	-	CuZn39Pb3 + PU
					(Ni or black Chrome)
Rubber shell-overlay:		EPDM	-	-	-

Environmental

Temperature range:	-20 °C to +65 °C	●	●	●	●
Solderability complies with	IEC 68-2-20	●	●	●	●

Ordering Information

Part Number	Shell	Contacts	Standards Compatibility	Remarks
-------------	-------	----------	-------------------------	---------

PX and PRX Series – 1/4" Professional Phone Plugs

NP2X	NP2RX	Nickel	Nickel	IEC 60603-11 / EIA RS-453	Mono plug, black bushing
NP2X-BAG	NP2RX-BAG	Black Cr	Nickel	●	Mono plug, black bushing
NP2X-B	NP2RX-B	Black Cr	Gold	●	Mono plug, black bushing
NP2X-WT	-	White painted	Nickel	●	Mono plug, white bushing
NP3X	NP3RX	Nickel	Nickel	●	Stereo plug, black bushing
NP3X-BAG	NP3RX-BAG	Black Cr	Nickel	●	Stereo plug, black bushing
NP3X-B	NP3RX-B	Black Cr	Gold	●	Stereo plug, black bushing
*-D	*-D				Bulk packed to be ordered in multiples of 100

silentPLUG – special 1/4" Guitar Plug

NP2X-AU-SILENT	Rubber overlay	Gold	IEC 60603-11 / EIA RS-453	Mono plug, silent switch
NP2RX-AU-SILENT	red coated	Gold	IEC 60603-11 / EIA RS-453	Right angle mono plug, silent switch

timbrePLUG – special 1/4" Guitar Plug

NP2RX-TIMBRE	red coated	Gold	IEC 60603-11 / EIA RS-453	Right angle mono plug, timbre switch
--------------	------------	------	---------------------------	--------------------------------------

ultimatePLUG – special 1/4" Guitar Plug

NP2RX-ULTIMATE	Black Cr	Gold	IEC 60603-11 / EIA RS-453	Right angle mono plug, timbre switch & silent switch
----------------	----------	------	---------------------------	--

crystalCON – 1/4" Professional Phone Plug

NP2X-B-CRYSTAL	Black Cr	Gold	IEC 60603-11 / EIA RS-453	Mono plug, black bushing, equipped with CRYSTALLIZED™ – Swarovski Elements
----------------	----------	------	---------------------------	--

jumboPLUG – 1/4" plug for thick instrument and loudspeaker cables

NP2XL	Nickel	Nickel	IEC 60603-11 / EIA RS-453	Mono plug, black bushing
NP3XL	Nickel	Nickel	●	Stereo plug, black bushing

C Series – 1/4" Professional Phone Plugs

NP2C	Nickel	Nickel	IEC 60603-11 / EIA RS-453	Mono plug, black bushing
NP2C-BAG	Black Cr	Nickel	●	Mono plug, black bushing
NP2C/B	Black Cr	Gold	●	Mono plug, black bushing and gold contacts
NP3C	Nickel	Nickel	●	Stereo plug, black bushing
NP3C-BAG	Black Cr	Nickel	●	Stereo plug, black bushing
NP3C/B	Black Cr	Gold	●	Stereo plug, black bushing and gold contacts
NP2C-BAG-T-AU	Black Cr	Nickel + T: Gold	●	Mono plug, black bushing with gold tip
NP2C-T10AA	Nickel	Nickel	●	Mono plug, red bushing, with built-in 1:10 transformer to convert microphone levels to guitar inputs
NP2RCS	Nickel + black plastic	Nickel	●	Mono right-angle plug, black bushing
NP3RCS	Nickel + black plastic	Nickel	●	Stereo right-angle plug, black bushing
NP*C-D				Bulk packed to be ordered in multiples of 100

Ordering Information

Part Number	Shell	Contacts	Standards Compatibility	Remarks
-------------	-------	----------	-------------------------	---------

MIL/B-gauge Type Phone Plugs

NP3TB-B	Black	Nickel	B-GAUGE BP0316	1/4" B-Gauge plug
NP3TB-R	Red	Nickel	●	1/4" B-Gauge plug
NP3TM-B	Black	Nickel	MIL-P-642/2	1/4" MIL plug
NP3TM-R	Red	Nickel	●	1/4" MIL plug
NP2CM-B	Black	Brass	MIL-P-642/4	Mono 1/4" MIL plug
NP2CM-R	Red	Brass	●	Mono 1/4" MIL plug
NP3CM-B	Black	Brass	MIL-P642/5A	Stereo 5.23 mm (0.206") MIL plug
NP3CM-R	Red	Brass	●	Stereo 5.23 mm (0.206") MIL plug

0.173" Bantam Type Miniature Plugs

NP3TT-1-B	Nickel + black plastic	Nickel	MIL-P-642/13	4.4 mm (0.173") Bantam plug with solder contacts, black sleeve
NP3TT-1-R	Nickel + red plastic	Nickel	●	4.4 mm (0.173") Bantam plug with solder contacts, red sleeve
NP3TT-AU-B	Nickel + black plastic	Gold	●	4.4 mm (0.173") Bantam plug with solder contacts, black sleeve
NP3TT-AU-R	Nickel + red plastic	Gold	●	4.4 mm (0.173") Bantam plug with solder contacts, red sleeve
NP3TT-P-B	Black plastic	Nickel	●	4.4 mm (0.173") Bantam plug with solder contacts, black sleeve
NP3TT-P-R	Red plastic	Nickel	●	4.4 mm (0.173") Bantam plug with solder contacts, red sleeve
NP3TT-P-AU-B	Black plastic	Gold	●	4.4 mm (0.173") Bantam plug with solder contacts, black sleeve
NP3TT-P-AU-R	Red plastic	Gold	●	4.4 mm (0.173") Bantam plug with solder contacts, red sleeve
NP3TT-2	Black plastic	Nickel	●	4.4 mm (0.173") Twin Bantam plug with solder contacts, black sleeve

3.5 mm Right-Angle Stereo Plug

NTP3RC	Nickel	Nickel	IEC 60603-11	3.5 mm audio plug with chuck and bushing
NTP3RC-B	Black Cr	Gold	IEC 60603-11	3.5 mm audio plug with chuck and bushing

Accessories



BSP-*



BPX-*



BSTT-*



BSTP-*



PXR-*



PCR-*



BPX-L

BSP-*	Colored bushing for NP*C Series
BPX-*	Colored bushing for NP*X Series
BPX-L	Large bushing with chuck type strain relief for for PX-Series. Accommodates cables to an O.D. of 7.0 - 8.0 mm.
BSTT-*	Colored sleeves for NP3TT Series
BSTP-*	Colored sleeves for NP3TT-P Series
PXR-*	Colored marking rings for NP*X Series
PCR-*	Colored marking rings for NP*C Series

*: Must be ordered in multiples of 100.

Black	Brown	Red	Orange	Yellow	Green	Blue	Violet	Grey	White
0	1	2	3	4	5	6	7	8	9

Assembly tool

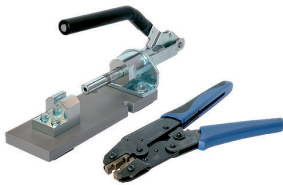

HX-TT-1



HX-R-BNC



HX-R-BNC-PJ



HTXP

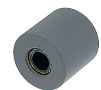

HTPXS

HX-TT-1	Assembly and crimp tool for NP3TT-1/AU
HX-R-BNC	HEX crimp tool for NP3TT-P*
DIE-R-BNC-PJ	HEX crimp die for NP3TT-P* (5.4 mm)
HTXP	Hand tool to tighten the PX and XX-bushing
HTPXS	Hand tool to hold shell of PX Plug

Locking Jacks



1/4" cable jack with locking



Neutrik cable retention

Locking 1/4" Cable Jacks



NJ3FC6



NJ3FC6-BAG

- Securely locking cable jack
- Mates with all mono or stereo plugs specified to EIA RS-453
- Extremely robust and reliable
- Excellent Neutrik cable retention
- Colored boots available in 10 colors
- For cable O.D.s up to 8 mm

NJ3FC6

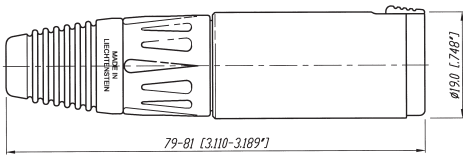

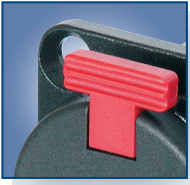

Release latch

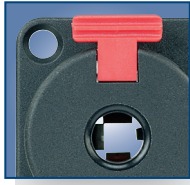

Standard D mounting dimensions

Locking 1/4" Chassis Jacks

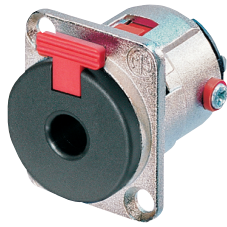

NJ3FP6C



NJ3FP6C-BAG

- Mates with all mono or stereo plugs specified to EIA RS-453
- Dimensionally compatible with D Series (31 x 26 mm)
- Securely locking chassis jack
- Solder terminals
- Special version with black plastic shell
- Choice of grounding option (see on www.neutrik.com)

NJ3FP6C

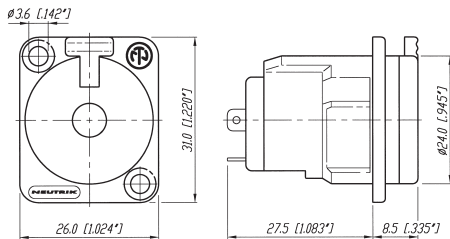



Snapping cap

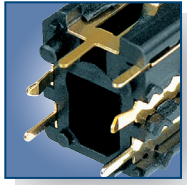

Solder tags

1/4" Vertical Jacks

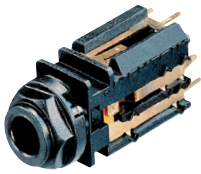

NJ*FD-V



NJ6TB-V

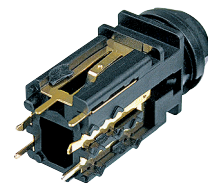

- Neutrik 1/4" Vertical PCB Jacks come in either standard 1/4" (FD) or mil gauge (TB) versions
- They feature a snap on/twist off cap which drastically reduces assembly times
- Retention force is provided by a special spring element independent of the contacts which results in optimal contact force with minimal contact wear
- Gold plated contact area for long durability and reliable, corrosion free operation

- High packing density compact design allows for more jacks in less space
- Available in Stereo switching and non-switching versions, and Mono non-switching version
- More than 10'000 insertion / withdrawal cycles

NJ*FD-V

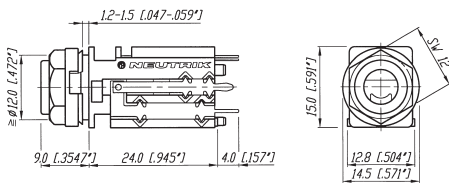

*: 2, 3, 5, 6



Half threaded nose



Chrome ferrule



Plastic nut

1/4" Jacks – M Jacks

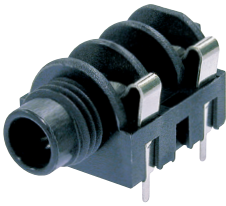

NMJ4HHD2

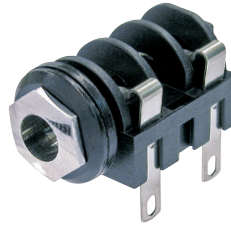

NMJ2HC-S



NMJ6HFD2

- Wide body and extremely durable contacts
- Available in all common versions:
 - mono
 - stereo
 - switched
 - unswitched
- Hardwire and PCB version
- Nose type in
 - half threaded
 - fully threaded
 - chrome ferrule
- Full threaded and chrome nose M Jacks are supplied with washer and fixing nut
- Mounting hardware for half threaded nose must be ordered separately
- Fascia appearance in plastic or chrome

NMJ6HHD2

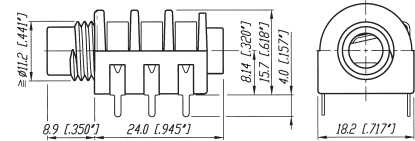

NMJ4HC-S

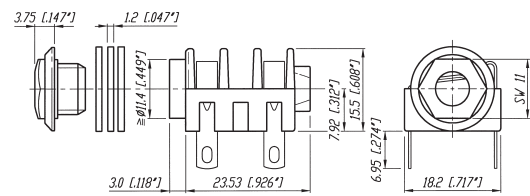

NRJ-NUT-B

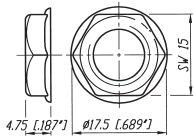

NRJ-WB (washer)

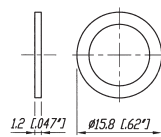

NMJ6HFD2

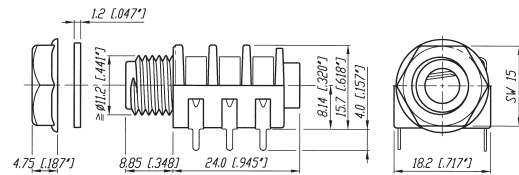



Half threaded nose



Chrome nose

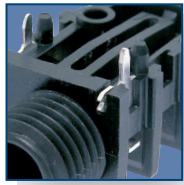

Chassis ground contact

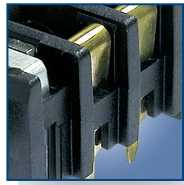

Gold plated contacts

1/4" Jacks – Slim Jacks

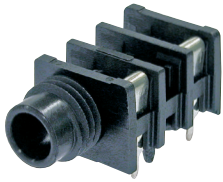

NRJ4HH-1

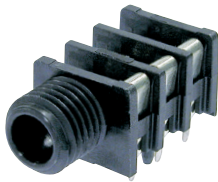

NRJ6HF-1



NRJ6HM-1



NRJ-NUT-B



NRJ-NUT-MK



NRJ-NUT-MS



NRJ-NUT-MN
(Metal Nose only)

- High board packing density
- Nose type in
 - half thread
 - fully threaded
 - metal
- *-1 versions meet the requirements of EMC rules through efficient chassis grounding system
- Retention spring ensures optimal grip on inserted plugs, avoiding the chance of lost connection
- All Slim line jacks have PCB horizontal mount pins
- Mounting nuts in different versions available – must be ordered separately

NRJ-NUT-B

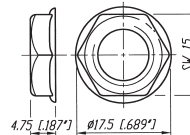

NRJ-NUT-MK

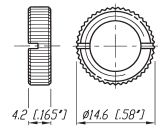

NRJ-NUT-MS

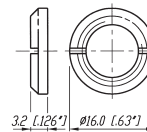

NRJ-NUT-MN

(Only compatible with metal nose).
Thread pitch is a 3/8" 32 UNEF 2A.

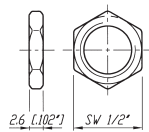

NRJ4HH-1

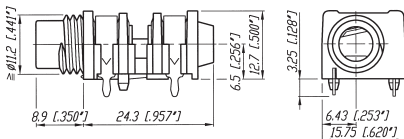

NRJ4HF-1

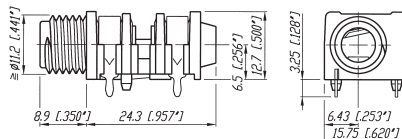

NRJ6HM-1

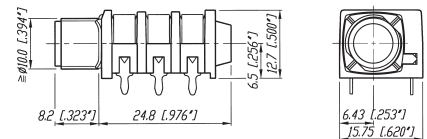



Plane nose



Quick fix nut



Fully threaded nose

1/4" Jacks – Stacking Jacks

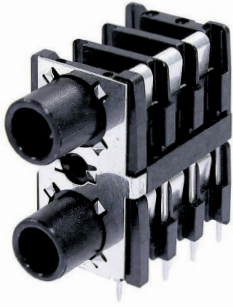

NSJ12HC

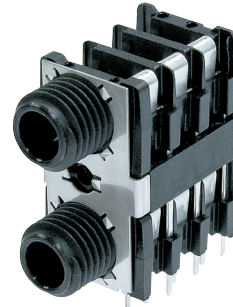

NSJ12HF-1

- Mono and stereo dual slim jack socket for PCB mounting with switch contacts
- Mounting method by either two quick fix or threaded nuts or one single center screw
- Highest board packing density as two jacks are in a single footprint, fit in 1 RU
- Version with fully and half threaded nose, full nose, quick-fit and plane

NSJ12HC

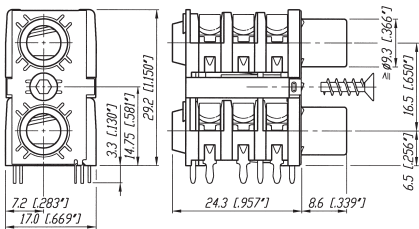

NSJ12HH-1

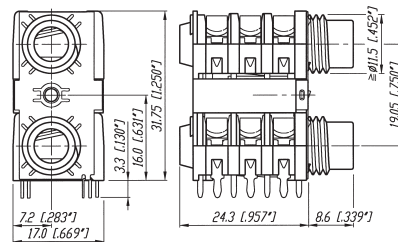

NRJ-NUT-B

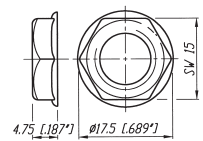

Specifications

Vertical
Jack

Locking
Cable & Chassis
Jack

M Jack

Slim Jack

Stacking
Jack

Electrical

Contact resistance	- initial	< 10 mΩ	< 6 mΩ	< 15 mΩ	< 10 mΩ	-
	- Top row	-	-	-	-	< 15 mΩ
	- Bottom row	-	-	-	-	< 10 mΩ
Switch contact resistance	- for silver	-	-	< 30 mΩ	< 25 mΩ	-
	- for gold	< 15 mΩ	-	-	< 10 mΩ	-
	- Top row	-	-	-	-	< 15 mΩ
	- Bottom row	-	-	-	-	< 10 mΩ
Insulation resistance	≥ 1GΩ @ 500 V dc	●	●	●	●	●
Dielectric strength	1 kV dc	●	●	●	●	●
Rated current	3 A	●	10 A	●	●	●
Rated switch contact current	0.5 A @ 50 V	0.25 A @ 12 V	-	●	●	●

Mechanical

Lifetime	> 10'000 cycles	●	●	●	●	●
Insertion / withdrawal force		<20N / >8N	<30N / >20N	<30N / >10N	<30N / >10N	<30N / >10N
Cap opening torque		25 N cm / 9.84 N in	-	-	-	-
Locking force		-	> 80 N	-	-	-
Wire size	(∅... max. for soldering tag)	-	1 mm ² / 18 AWG ∅	-	-	-
Cable O.D. (FC6 only)		-	3.5 - 8.0 mm	-	-	-
Panel thickness		1.2 - 1.5 mm [0.047 - 0.06"]	-	-	-	-
	- Full nose type	-	-	< 3.0 mm	< 3.0 mm	-
	- Half nose type	-	-	< 1.0 mm	< 1.0 mm	-
	- Chrome nose	-	-	< 4.7 mm	-	-
	- NSJ*HL	-	-	-	-	1.0 - 1.6 mm
	- NSJ*HC	-	-	-	-	> 1.0 mm

Material

Shell / Handle	PA 6.6 30% GR	●	ZnAl4Cu1	●	●	●
Shell Coating	Ni or black	-	●	-	-	-
	- FP6P: (PA 6.6 30% GR)	-	●	-	-	-
Insulation	PA 6.6 30% GR	-	●	-	-	-
Contacts	CuSn6	●	CuBe2/CuZn37 (ground)	●	●	●
Contact surface	gal 2 μm Ag / 0.2 μm Au	0.2 μm Au	2 μm Ag	●	●	gal 2 μm Ag
Cap / Nut / Washer	PA 6.6 30% GR	POM	-	●	●	●
Ring Nut	Brass (Ni plated)	-	-	-	●	●
Chuck	-	-	POM	-	-	-
Bushing	-	-	PA 6.6 15% GR + PUR	-	-	-

Environmental

Solderability complies with	IEC 60068-2-20	●	●	●	●	●
Standard Compatibility						
	EIA RS 453 + IEC 60603-11	NJ*FD	●	●	●	●
	B-GAUGE BPO 316, MIL-J-641/3	NJ*TB	-	-	-	-
Temperature range	-25 °C to +70 °C	●	●	●	●	●
Flammability	UL94 V-0	-	●	●	●	●

Circuits:

Mono unswitched

Mono switched

Stereo unswitched

2x switching
(normalling) Stereo

3x switching
(normalling) Stereo

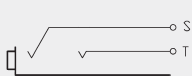

N*J2**

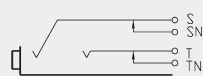

N*J4**

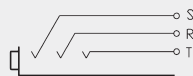

N*J3**

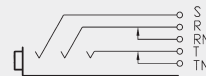

N*J5**

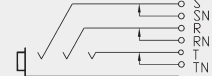

N*J6**

EXCEPTION: NRJ*HM-1-PRE & NRJ*HH(F)-1 Sleeve not switched

Ordering Information

Part Number	Shell	Contacts	Terminations	Standards Compatibility	Remarks
-------------	-------	----------	--------------	-------------------------	---------

Slim Jack – 1/4" Horizontal Jack

PCB Mount Sockets - Switched

Part Number	Shell	Contacts	Terminations	Standards Compatibility	Remarks
NRJ3HF-1	Black/Plastic	Silver	Horizontal PCB mount	IEC 60603-11/EIA RS 453	Stereo, full threaded nose, chassis ground contact
NRJ4HF	●	●	●	●	Mono, full threaded nose
NRJ4HF-1	●	●	●	●	Mono, full threaded nose, chassis ground contact
NRJ6HF	●	●	●	●	Stereo, full threaded nose
NRJ6HF-1	●	●	●	●	Stereo, full threaded nose, chassis ground contact
NRJ4HH	●	●	●	●	Mono, half threaded nose
NRJ4HH-1	●	●	●	●	Mono, half threaded nose, chassis ground contact
NRJ6HH	●	●	●	●	Stereo, half threaded nose
NRJ6HH-1	●	●	●	●	Stereo, half threaded nose, chassis ground contact
NRJ6HF-AU	●	Gold	●	●	Stereo, full threaded nose, gold plated contacts
NRJ6HF-1-AU	●	Gold	●	●	Stereo, full threaded nose, chassis ground contact, gold plated contacts
NRJ6HH-AU	●	Gold	●	●	Stereo, half threaded nose, gold plated contacts
NRJ-NUT-B	●	-	-	-	Hexagonal black plastic nut
NRJ-NUT-R	Red/Plastic	-	-	-	Hexagonal red plastic nut
NRJ-NUT-MK	Metal/Ni plated	-	-	-	Metal ring nut, knurled
NRJ-NUT-MS	Metal/Ni plated	-	-	-	Metal ring nut

PCB Mount Sockets - Switched with Metal Nose

Part Number	Shell	Contacts	Terminations	Standards Compatibility	Remarks
NRJ6HM-1	Black/Plastic	Silver	Horizontal PCB mount	IEC 60603-11/EIA RS 453	Stereo, metal threaded nose
NRJ6HM-1-AU	●	Gold	●	●	Stereo, metal threaded nose, gold plated contacts
NRJ-NUT-MN	Metal	-	-	-	Hexagonal metal nut (for metal nose jack only)

Stacking Jack – 1/4" Horizontal Jack

Part Number	Shell	Contacts	Terminations	Standards Compatibility	Remarks
NSJ12HC	Polyamid PA 6.6 30% GR	Silver	Horizontal PCB mount	IEC 60603-11/EIA RS 453	Stereo, full nose
NSJ12HF-1	●	●	●	●	Full threaded nose

*... UL94 V-0

All Slim jacks are for PCB mount only.
Mounting nuts must be ordered separately.

Ordering Key:

NRJ*H	NEUTRIK® Jack Horizontal	*	number of contacts:
H	half threaded nose	2	mono unswitched
F	full threaded nose	4	mono switched
M	metal threaded nose	6	stereo switched
C	plane nose	8	mono stacking jack
-1	chassis ground contact	12	stereo stacking jack

Nose:

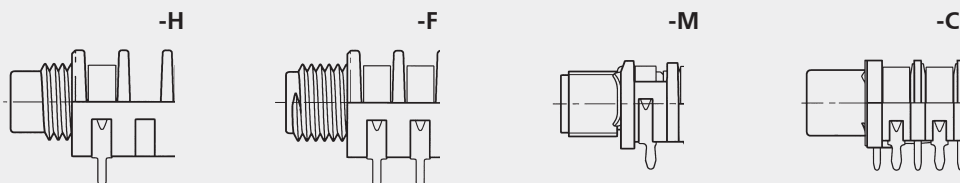

Part Number	Shell	Contacts	Terminations	Standards Compatibility	Remarks
-------------	-------	----------	--------------	----------------------------	---------

1/4" Locking Jack

NJ3FC6	Nickel	Silver	Wire soldering	IEC 60603-11/EIA RS 453	Cable Jack
NJ3FC6-BAG	Black	•	•	•	•
NJ3FP6C	Nickel	•	•	•	Chassis Jack
NJ3FP6C-B	Black	Gold	•	•	•
NJ3FP6C-BAG	Black	Silver	•	•	•
NJ3FP6F-P	Black/Plastic	•	Flat tabs	•	Plastic Chassis
NJ3FP6P-BAG	Black/Plastic	•	•	•	Plastic Chassis

1/4" Vertical Jack

NJ2FD-V	Black/Plastic	Gold	Vertical PCB mount	IEC 60603-11/EIA RS 453	Non-switching Mono Jack (T/S)
NJ3FD-V	•	•	•	•	Non-switching Stereo Jack (T/R/S)
NJ5FD-V	•	•	•	•	2 x switching (normalling) Stereo jack (T/TN/R/RN/S)
NJ6FD-V	•	•	•	•	3 x switching (normalling) Stereo jack (T/TN/R/RN/S/SN)
NJ6TB-V	•	•	•	B-Gauge BPO316 Mil-J-641/3	3 x switching (normalling) Stereo jack (T/TN/R/RN/S/SN)

M Jack – 1/4" Horizontal Jack

NMJ2HF-S	Black/Plastic	Silver	Horizontal PCB mount	IEC 60603-11/EIA RS 453	Mono, unswitched, full threaded nose, solder tags
NMJ3HF-S	•	•	•	•	Stereo, unswitched, full threaded nose, solder tags
NMJ4HF-S	•	•	•	•	Mono, switched, full threaded nose, solder tags
NMJ2HC-S	•	•	•	•	Mono, unswitched, Chrome ferrule, solder tags
NMJ4HC-S	•	•	•	•	Mono, switched, Chrome ferrule, solder tags
NMJ4HFD2	•	•	•	•	Mono, switched, full threaded nose, PCB mount
NMJ4HFD3	•	•	•	•	Mono, switched, full threaded nose, offset PCB mount
NMJ4HCD2	•	•	•	•	Mono, switched, Chrome ferrule, PCB mount,
NMJ4HHD2	•	•	•	•	Mono, switched, half threaded nose, PCB mount, without nut and washer
NMJ6HF-S	•	•	•	•	Stereo, switched, full threaded nose, solder tags
NMJ6HC-S	•	•	•	•	Stereo, switched, Chrome ferrule, solder tags
NMJ6HCD2	•	•	•	•	Stereo, switched, Chrome ferrule, PCB mount
NMJ6HHD2	•	•	•	•	Stereo, switched, half threaded nose, PCB mount, without nut and washer
NMJ6HFD2	•	•	•	•	Stereo, switched, full threaded nose, PCB mount
NMJ6HFD2-AU	•	Gold	•	•	Stereo, switched, full threaded nose, PCB mount
NMJ6HFD3	•	•	•	•	Stereo, switched, full threaded nose, offset PCB mount
NMJ6HCD3	•	•	•	•	Stereo, switched, Chrome ferrule, offset PCB mount
NMJ6HFD4	•	•	•	•	Stereo, switched, full threaded nose, tear drop PCB mount

Full threaded and Chrome nose M-Jacks are supplied with fixing nut and washers.
Mounting hardware for half threaded nose must be ordered separately.

Ordering Key:

NMJ*H	NEUTRIK M Jack Horizontal	*	number of contacts:
H	half threaded nose	2	mono unswitched
F	fully threaded nose	3	stereo unswitched
C	chrome nose	4	mono switched
-S	solder tag	5	stereo switched (T/S)
D2	PCB pins 02	6	stereo switched (T/R/S)
D3	PCB pins 03		

Pins:

-S

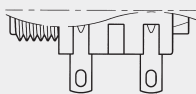

-D2



-D3



Accessories



BSX-*



DSS



SCDR



Example



NDJ



NZP1RU-12



SCDX



Example



SCCD-W



SCDP-*



MFD



Example



NRJ-NUT-MS



NRJ-NUT-MN



NRJ-NUT-MK



NRJ-NUT-R



NRJ-NUT-B

BSX-*	Bushing for color coding.
DSS-*	Lettering plate, colored plastic
SCDR	Rear end protection cover for locking 1/4" chassis jack
NDJ	dummyPLUG for 1/4" chassis jack
NZP1RU-8	Panel 1RU housing with 8 D-shape cutouts
NZP1RU-12	Panel 1RU housing with 12 D-shape cutouts
SCDX	Hinged cover seals locking 1/4 chassis jack, IP42 rated
SCCD-W	Spring-loaded cover to seals locking 1/4 chassis jack, IP 65
SCDP-*	D-Size sealing gaskets, color coding (*: 0- black, 2- red, 4- yellow, 5- green, 6- blue, 9- white)
MFD	The fixing plate with M3 thread offers efficient and ease mounting of all D-sized chassis connectors by M3 screws.
NRJ-NUT-MS	Nickel plated metal ring nut
NRJ-NUT-MN	Hexagonal metal nut (for metal nose jack only)
NRJ-NUT-MK	Ring nut, knurled, nickel-plated brass
NRJ-NUT-R	Hexagonal red plastic nut
NRJ-NUT-B	Hexagonal black plastic nut
NDJ	The dummyPLUG NDJ for Neutrik 1/4" Jacks enables you to simplify cabling. Unused inputs can be covered to avoid miss wiring and protect against dust additionally.

*: Must be ordered in multiples of 100.

Black	Brown	Red	Orange	Yellow	Green	Blue	Violet	Grey	White
0	1	2	3	4	5	6	7	8	9



Simple housing

plug2PLUG

1/4" Inline Adapter – plug2PLUG



NA2JJ



Application: 1/4" Phone Plug to 1/4" Phone Plug

- The plug2PLUG is a simple yet sophisticated plug adapter for a quick and easy connection of two mono TS plugs.

NA2JJ

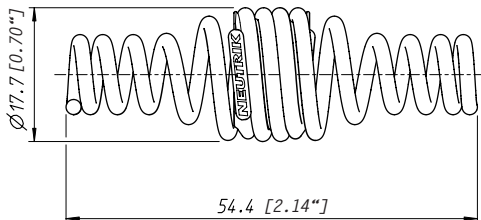

Ordering Information

plug2PLUG

NA2JJ 2 pole coupler to extend two 2 pole 1/4" Phone Plugs



Gold plated contacts



Soft-touch surface

Profi[®]

Profi[®] RCA Series



NF2C-B2

- Makes ground before signal contact and breaks signal before ground
- No more disturbing noise and broken speaker cones
- Precisely machined to our demanding quality standards
- Neutrik unique chuck type strain relief
- Gold plated contacts
- Sleek barrel with soft touch surface and colored shrink sleeve
- Improved ground solder lug for ease soldering

NF2C-B2

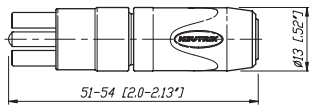

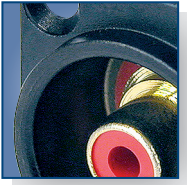

Gold plated Phono socket

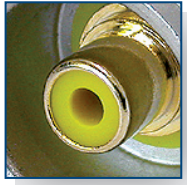

Colored washer

Phono Socket



NF2D-4



NF2D-B-6

- Precisely machined to our demanding quality standards
- Phono socket in D-shape housing
- Gold plated contacts
- Isolation washers in 9 colors available

NF2D-*

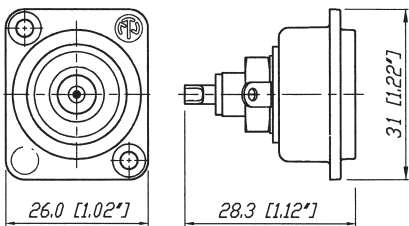

*: available in 9 colors see page 28

Specification		Profi®	Phono Socket
---------------	--	--------	--------------

Electrical

Rated current per contact	10 A rms continuous	●	●
Rated insulation voltage	50 V ac	●	●
Insulation resistance		> 100 GΩ	< 5 GΩ
Dielectric strength		1.5 kV dc	0.5 kV dc
Capacitance (pin to shell)		7 pf	9 pf

Mechanical

Life time (mating cycles)	> 2000	●	●
Cable O.D. range	3.0 – 7.3 mm	●	-
Wiring	soldering	●	●
Max. wire size	2.5 mm ² / AWG 14	●	-
Cable anchoring	Neutrik® chuck type strain relief	●	-

Material

Housing	Brass (CuZn39Pb3)	●	-
	Zinc diecast (ZnAlCu1)	-	●
Insert	PBTP 20% GR	●	-
Contacts	Brass (CuZn39Pb3)	●	●
Contact plating	0.05 μm Au plated over 2 μm Ni	●	●
Chuck	Polyacetal (POM)	●	-

Environment

Temperature range	-30 °C to +80 °C	●	●
Protection class	IP 40	●	●
Flammability	UL 94 HB	●	●
Solderability	complies with IEC 68-2-20	●	●

Ordering Information

Phono Profi®

NF2C-B2	Professional "phono Plug" (RCA or CINCH type), two plugs with red and black coding, two strain relief chucks for a second cable diameter
---------	--

Phono (RCA) Socket

NF2D-*	Chassis Phono (RCA) socket in D Shape housing
NF2D-B-*	Chassis Phono (RCA) socket in black D Shape housing
* color coding: 0 - Black, 1- Brown, 2 - Red, 3 - Orange, 4 - Yellow, 5 - Green, 6 - Blue, 7 - Violet, 8 - Grey, 9 - White	

Accessories

NDP	Dummy plug for phone socket
NZP1RU-8	Panel 1RU housing with 8 D-shape cutouts
NZP1RU-12	Panel 1RU housing with 12 D-shape cutouts
SCL	Plastic sealing cover to protect the connector sockets against dust and moisture
SCDP-*	D-Size sealing gaskets, colour coding (*: 0- black, 2- red, 4- yellow, 5- green, 6- blue, 9- white)
SCDX	Hinged cover seals D-size chassis connectors, IP 42 rated
SCCD-W	Spring-loaded cover to seals D-size chassis connectors, IP 65 rated

Definitions, Abbreviations & Useful Information

ELEMENTS

Ag	Silver
Al	Aluminium
Au	Gold
Co	Cobalt
Cr	Chromium
Cu	Copper
Ni	Nickel
P	Phosphorus
Pb	Lead
Pd	Palladium
Sn	Tin
Zn	Zinc
SS	Stainless Steel

ALLOYS, PLASTICS, POLYMERS

Brass (Alloy)	CuZn39Pb3
Bronze (Alloy)	CuSn6
Ck 67	Carbon Steel
EPDM	Ethylene Propylene
GR	Glass Reinforced
PA	Polyamide
PBTP	Polybutylene Terephthalate
POM	Polyacetal
PTFE	PolyTetraFluoroEthylene (TEFLON)
PUR	Polyurethane

MEASUREMENT LEGEND

N	Newton
Ω	Ohm
μ	Micro
OD	Outside Diameter
m	Meter(s)
k	Kilo

ENGLISH TO METRIC CONVERSIONS



1/8 inch	3.175	millimeters (mm)
1/4 inch	6.35	millimeters (mm)
1 inch	25.4	millimeters (mm)
	2.54 cm	1 inch
1 foot	30.48	centimeters (cm)
	0.305	meter (m)
6 foot	1.828	meters (m)
50 foot	15.24	meters (m)
100 foot	30.48	meters (m)
1000 foot	304.8	meters (m)

METRIC TO ENGLISH CONVERSIONS

1 centimeter	0.3937	inches
1 meter	39.37	inches
3.281 meter	10	feet
10 meters	32.808	feet
50 meters	164.041	feet
100 meters	328.084	feet

OTHER ABBREVIATIONS

UL®	Underwriters Laboratories
IP Rating	Ingress Protection rating for objects and water ACC IEC529/EN60529
IEC	International Electrotechnical Commission is the international standards and conformity assessment body for all fields of electrotechnology
	UL Recognized Component Mark

	ENEC – European norms electrical certification, demonstrates compliance with European safety standards.
	VDE Association for Electrical, Electronic and Information Technologies e.V.
AWG	American Wire Gauge

NEUTRIK, crystalCON®, etherCON®, maxCON®, miniCON®, nanoCON®, neutriCON®, opticalCON®, powerCON®, Profi®, rearTWIST®, silentPLUG®, speakON®, TOP®, DiWA®, XIRIUM®, are registered trademarks of Neutrik AG.

Neutrik® Part Number Guide

NC3FAH1-B-0-D

Packaging:	D	Cable connector: bulk packed
Assembly:	D	Chassis connector: disassembled push latch
Retention:	w/o	Latch lock
	-0	Retention spring
	-DA	Asymmetric PUSH
Shell:	B	Black shell, gold contacts
	BAG	Black shell, silver contacts
Grounding:	0	Separate ground contact connected to shell, male only
	1	Pin 1 & panel & shell connected, no separate ground contact
	2	Separate ground contact connected to shell & panel, separate Pin 1
	E	Additional ground contacts
	w/o number	No ground/shell contact (except 4/5 pole), female only
Termination:	H	Horizontal PCB mount
	HL	Lateral left PCB mount
	HR	Lateral right PCB mount
	L	Solder cups
	V	Vertical PCB mount
	Y	IDC for wires (no ground)
	M3	Mounting holes with M3 thread
	M25	Mounting holes with M2.5 thread
	-	Not applicable
	Series:	A, AA, B, D, DL, DLX, MPR, P, PX, RX, X, XX
Gender:	F	Female
	M	Male
Number of Contacts:	2, 3, 4, 5, 6, 7, 8, 12	
Connector Type:	A	Adapter
	AC	powerCON
	B	BNC
	C	XLR
	D	dummyPLUG
	E	etherCON - RJ45
	F	RCA / CINCH
	J (MJ, RJ, SJ)	Jack
	K	Cable Assembly
	L	speakON - Loudspeaker
	M	Module
	O	opticalCON - Fiber Optic Connector
	P	Plug
	PP	Patch Panel
	R	Circular Connector
	T	Transformer
	TOP	True Outdoor Protection

Definitions, abbreviations & useful information see page 29.

Neutrik® Product Line

<p>XLR Connectors</p>	<p>Plugs & Jacks</p>	<p>SpeakON® Connectors</p>	<p>Data Connectors</p>	<p>Circular Connectors</p>	<p>powerCON® Connectors</p>	<p>Patch Panels</p>	<p>Digital Devices</p>
------------------------------	---------------------------------	-----------------------------------	-------------------------------	-----------------------------------	------------------------------------	----------------------------	-------------------------------

NEUTRIK®

The premium brand of the Neutrik Group

LIECHTENSTEIN (HEADQUARTERS)

Neutrik AG, Im alten Riet 143, 9494 Schaan
T +423 237 24 24, F +423 232 53 93, neutrik@neutrik.com

GERMANY / NETHERLANDS / DENMARK / AUSTRIA

Neutrik Vertriebs GmbH, Felix-Wankel-Straße 1, 85221 Dachau, Germany
T +49 8131 28 08 90, neutrik@neutrik.de

GREAT BRITAIN

Neutrik (UK) Ltd., Westridge Business Park, Cothey Way
Ryde, Isle of Wight PO33 1 QT
T +44 1983 811 441, sales@neutrik.co.uk

FRANCE

Neutrik France SARL, 52 rue d'aguesseau, 1er etage, 92100 Boulogne-Billancourt
T +33 1 41 31 67 50, info@neutrik.fr

USA

Neutrik USA Inc., 4115 Taggart Creek Road, Charlotte, North Carolina, 28208
T +1 704 972 3050, info@neutrikusa.com

JAPAN

Neutrik Limited, Yusen-Higashinohonbashi-Ekimae Bldg., 3-7-19
Higashinohonbashi, Chuo-ku, Tokyo 103
T +81 3 3663 47 33, mail@neutrik.co.jp

HONG KONG

Neutrik Hong Kong Ltd., Suite 18, 7th Floor Shatin Galleria
Fotan, Shatin
T +852 2687 6055, sales@neutrik.com.hk

CHINA

Ningbo Neutrik Trading Co., Ltd., Shiqi Street, Yinxian Road West
Fengjia Villiage, Hai Shu Area, Ningbo, Zhejiang, 315153
T +86 574 88250833, sales@neutrik.com.cn

ASSOCIATED COMPANIES

Contrik AG

Steinackerstrasse 35, 8902 Urdorf, Switzerland
T +41 44 736 50 10, contrik@contrik.ch

H. Adam GmbH

Felix-Wankel-Straße 1, 85221 Dachau, Germany
T +49 08131 28 08-0, anfrage@adam-gmbh.de



www.neutrik.com